

Vickers®

Cylinders



Series TZ Cylinders

ANSI B93.15/NFPA Interchangeable
Nominal Pressure: 3000 psi (210 bar)



Contents

| | |
|--|----|
| Features | 2 |
| How to Order | 3 |
| Model Code | 4 |
| Mounting Style | 6 |
| Mounting Style & Installation Dimensions | 8 |
| TZ01 Side Lug Mounts | 8 |
| TZ02 Tapped Mounts | 9 |
| TZ04 Keyed Side Lug Mounts | 10 |
| TZ05 Keyed Tapped Mounts | 11 |
| TZ07 Head Rectangular Mounts | 12 |
| TZ08 Head Square Flange Mount | 14 |
| TZ09 Head Rectangular Mounts | 15 |
| TZ10 Clevis Mount | 16 |
| TZ12 Cap Rectangular Flange | 17 |
| TZ13 Cap Square Flange | 18 |
| TZ14 Cap Rectangular Mounts | 19 |
| TZ15 Intermediate Trunnion Mount | 20 |
| TZ16 Cap Trunnion Mounts | 21 |
| TZ17 Head Trunnion Mounts | 23 |
| TZ19 Centerline Lug Mounts | 25 |
| TZ21 Cap Extended Tie Rod Mounts | 26 |
| TZ22 Head Extended Tie Rod Mounts | 27 |
| TZ23 Both Ends Extended Tie Rod Mounts | 29 |
| TZ24 No Mount | 30 |
| TZ25 Double Rod End, Side Lug Mounts | 32 |
| Accessories | 33 |
| Common Options Section | 35 |
| Application / Engineering Data | 42 |
| Application Data | 46 |
| Weights | 53 |

Features

Global Design:

Engineered for ANSI B93.15/NFPA interchangeability with the durability required for heavy-duty applications.

Rod Cartridge Assembly:

Quick Change design requires no other cylinder disassembly for rod seal maintenance.

SureSeal™ Sealing System:

Carefully selected wiper and seal combinations are mated with a hard chrome plated piston rod to deliver exceptional all-around performance and durability.

Special Wearbands:

Metal-to-metal contact is eliminated, providing superior wearability, increased load carrying capability, and prolonged cylinder life.

Piston Sealing System:

This system offers not only a selection of highly efficient seal materials, but also an extra wide wearband that rides smoothly within the precision-honed cylinder body to provide extended piston seal life.

Square Head Tie-Rod Design:

Suitable for nominal working pressure up to 3000 psi.

Full Range of Ports:

Including SAE, ISO 228-1 BSPP, and metric to ISO 6149 and DIN standard 3852 to provide the broadest piping flexibility.

Piston Rod:

Case hardened, hard chrome plated piston rod in a variety of diameters between $\frac{5}{8}$ and $5\frac{1}{2}$ inches provides maximum durability and extends seal life. Several different rod end types are available.

ISO Standard Seal Grooves:

Rod and piston sealing systems both conform to ISO standard groove specifications.

Captive Screws:

Inadvertent removal of cushion screws and optional air bleed screws is prevented, while still allowing a full range of adjustment.

Bore Size Range:

Cylinder bores available between $1\frac{1}{2}$ and 8 inches.

Fully Adjustable Cushioning System:

This design has been engineered to provide the ability to tune the cushion performance for an optimized deceleration profile. Our patented floating ring cushion seal or an alternate ball check design allows maximum acceleration. This excellent acceleration profile translates into faster cycle times and increased machine production.

Attention to Details:

One example is the careful design of the body-to-head joint. The design assures ease of assembly while maintaining tight tolerances for exceptional concentricity between cylinder parts.

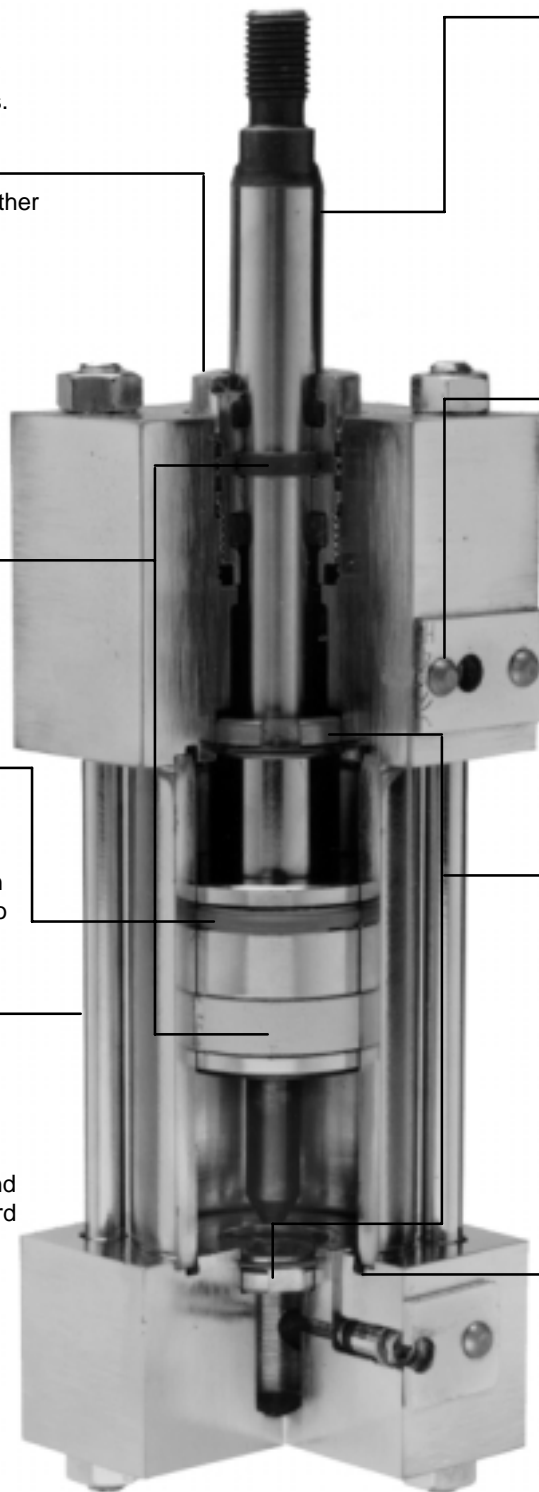

How To Order

Standard Cylinders

Vickers has created an easy system for ordering Series TZ Cylinders. This system has been developed to improve our service to you. The model code consists of sixteen alpha-numeric digits which fully describe the most common standard options offered on Series TZ cylinders.

To specify your Series TZ cylinder, review the following pages for a full description of each option available and select the desired code.

This model code system will:

- **Simplify the re-order process.**
Each Vickers Series TZ cylinder is assigned a sixteen digit model code. That code is unique to a particular cylinder description. That way, when you re-order your Series TZ cylinder, you're assured of exactly the same top quality cylinder design.
- **Improve identification.**
Every Series TZ cylinder has its sixteen digit model code clearly marked on the product, impression stamped in the metal head or cap. Each sixteen digit code completely describes a specific cylinder. This allows seals and replacement components to be easily identified in the field.
- **Facilitate communications.**
This fully descriptive model code system allows you to work directly with your local Vickers sales engineer to identify and service your Vickers cylinder.

NOTE

See pages 4 and 5 for a summary of model code options.

Custom Cylinders

New Cylinders

Although the model code has been arranged to cover the vast majority of available options, there will be occasions when you require an option which cannot be coded. When specifying such an option, enter an "X" for the appropriate item in the sixteen digit model code, then describe your requirements. For example, if you have an application which requires a custom thread on the end of the piston rod, enter an "X" for item 7. Then add a full description at the end of the model code, such as "With 3.25 inch total rod projection and M22 x 1,5 thread 1.375 inches long." The cylinder will then be given a unique five digit design number on receipt of order (as explained below).

If more than one of the available options represented in items 15 and 16 are required, add the appropriate codes as a suffix. The cylinder will then be given a unique five digit design number on receipt of order (as explained below).

Replacement Cylinders

Every Vickers custom cylinder is assigned a unique design number. This number is contained in the last five digits of the sixteen digit model code, and item 12 is always a alpha character. In other words, the "Stroke" and "Extra Rod Projection" locations (items 12 through 16) become the "Design Number" items for custom cylinders. When ordering a replacement cylinder, simply give the sixteen digit model code or the five digit design number to your local Vickers Sales Representative.

Replacement Parts

Each design number is stored in a quick retrieval computerized storage system. This gives our field sales representatives rapid access to assist you in identifying and specifying genuine Vickers replacement parts.

Model Codes

(All dimensions are in inches)

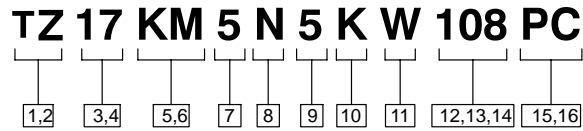

1,2 Series

TZ – ANSI B93.15/NFPA interchangeable hydraulic cylinder

3,4 Mounting style

Vickers

| Code | Style | ANSI Code |
|------|--|-----------|
| 01 | Side lug | MS2 |
| 02 | Side tapped | MS4 |
| 04 | Keyed side lug | |
| 05 | Keyed side tapped | |
| 07 | Head rectangular flange | MF1 |
| 08 | Head square flange | MF5 |
| 09 | Head rectangular | ME5 |
| 10 | Cap clevis | MP1 |
| ** | Spherical bushing | MP5 |
| 12 | Cap rectangular flange | MF2 |
| 13 | Cap square flange | MF6 |
| 14 | Cap rectangular | ME6 |
| 15 | Intermediate trunnion | MT4 |
| 16 | Cap trunnion | MT2 |
| 17 | Head trunnion | MT1 |
| 19 | Centerline lug | MS3 |
| 21 | Cap extended tie rod | MX2 |
| 22 | Head extended tie rod | MX3 |
| 23 | Both ends extended tie rod | MX1 |
| 24 | No mount | |
| 25 | Double rod, side lug | |
| 26 | Double rod, side tapped | |
| 28 | Double rod, keyed side lug | |
| 29 | Double rod, keyed side tapped | |
| 31 | Double rod, rectangular flange | |
| 32 | Double rod, square flange | |
| 33 | Double rod, head rectangular | |
| 34 | Double rod, intermediate trunnion | |
| 35 | Double rod, head trunnion | |
| 37 | Double rod, centerline lug | |
| 39 | Double rod, extended tie rod | |
| 40 | Double rod, both ends extended tie rod | |
| 41 | Double rod, no mount | |

(See illustrations beginning on page 6.)

** – MP5 spherical bushing mountings are available in the Series JV catalog.

5,6 Bore and rod diameters

| Code | Bore | Rod |
|------|-------------------------------|--------------------------------|
| CC | 1 ¹ / ₂ | 5 ⁵ / ₈ |
| CE | 1 ¹ / ₂ | 1 |
| DE | 2 | 1 |
| DH | 2 | 13 ³ / ₈ |
| EE | 2 ¹ / ₂ | 1 |
| EH | 2 ¹ / ₂ | 13 ³ / ₈ |
| EL | 2 ¹ / ₂ | 13 ³ / ₄ |
| GH | 3 ¹ / ₄ | 13 ³ / ₈ |
| GL | 3 ¹ / ₄ | 13 ³ / ₄ |
| GM | 3 ¹ / ₄ | 2 |
| HL | 4 | 13 ³ / ₄ |
| HM | 4 | 2 |
| HP | 4 | 2 ¹ / ₂ |
| KM | 5 | 2 |
| KP | 5 | 2 ¹ / ₂ |
| KU | 5 | 3 |
| KV | 5 | 3 ¹ / ₂ |
| LP | 6 | 2 ¹ / ₂ |
| LU | 6 | 3 |
| LV | 6 | 3 ¹ / ₂ |
| LW | 6 | 4 |
| MU | 7 | 3 |
| MV | 7 | 3 ¹ / ₂ |
| MW | 7 | 4 |
| MY | 7 | 4 ¹ / ₂ |
| MZ | 7 | 5 |
| NV | 8 | 3 ¹ / ₂ |
| NW | 8 | 4 |
| NY | 8 | 4 ¹ / ₂ |
| NZ | 8 | 5 |
| N1 | 8 | 5 ¹ / ₂ |

(See detailed information on page NO TAG.)

7 Rod end type

| Code | Type |
|------|--|
| 1 | Short female metric thread |
| 2 | Short female UN thread |
| 5 | Small male UN thread |
| 6 | Plain no attachment |
| 7 | Small male metric thread |
| 9 | Intermediate male UN thread |
| 0 | Intermediate male metric |
| G | Grooved end |
| K | Extended small male UN thread |
| L | Extended small male metric thread |
| M | Extended intermediate male UN thread |
| N | Extended intermediate male metric thread |

(See detailed information on pages NO TAG & NO TAG.)

8 Sealing system

| Code | Type |
|------|-------------------------------|
| N | Normal |
| L | Low friction and water glycol |
| T | High temperature |

(See detailed information on page NO TAG.)

9 Port type and size

| Code | Type |
|------|----------------------|
| 1 | NPTF* |
| 2 | Oversize NPTF* |
| 3 | SAE/UN O-ring |
| 4 | Oversize SAE/UN |
| 5 | NFPA standard SAE/UN |
| 6 | SAE 4-bolt manifold |
| 7 | BSPP |
| 8 | Oversize BSPP |
| 9 | Metric |
| 0 | Oversize metric |

(See detailed information on page NO TAG.)

* – Not recommended for maximum reliability on new applications.

10 Port location

Ports are located as shown below when viewing cylinder from head end (mounting end of double rod cylinder).

With some mounting styles, certain port locations cannot be selected due to interference with the mounting.

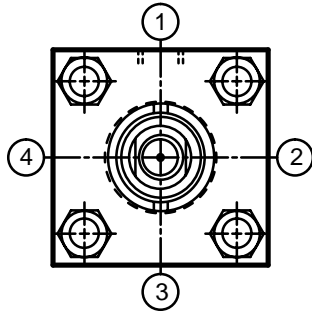

| Code | Head | Cap |
|------|------|-----|
| K- | 1 | 1 |
| L- | 1 | 2 |
| M- | 1 | 3 |
| N- | 1 | 4 |
| P- | 2 | 1 |
| R- | 2 | 2 |
| S- | 2 | 3 |
| T- | 2 | 4 |
| U- | 3 | 1 |
| V- | 3 | 2 |
| W- | 3 | 3 |
| Y- | 3 | 4 |
| 1- | 4 | 1 |
| 2- | 4 | 2 |
| 3- | 4 | 3 |
| 4- | 4 | 4 |

(See detailed information on page NO TAG.)

11 Cushion location

Cushions are located as shown in item 7 when viewing cylinder from head end (mounting end of double rod cylinders). “-” in table indicates no cushion.

| Code | Head | Cap |
|------|------|-----|
| A- | - | 0 |
| B- | - | 1 |
| C- | - | 2 |
| D- | - | 3 |
| E- | - | 4 |
| F- | 1 | - |
| G- | 2 | - |
| H- | 3 | - |
| J- | 4 | - |
| K- | 1 | 1 |
| L- | 1 | 2 |
| M- | 1 | 3 |
| N- | 1 | 4 |
| P- | 2 | 1 |
| R- | 2 | 2 |
| S- | 2 | 3 |
| T- | 2 | 4 |
| U- | 3 | 1 |
| V- | 3 | 2 |
| W- | 3 | 3 |
| Y- | 3 | 4 |
| 1- | 4 | 1 |
| 2- | 4 | 2 |
| 3- | 4 | 3 |
| 4- | 4 | 4 |

12,13,14 Stroke length

The first two digits indicate stroke length from 00 inches through 99 inches.

The third indicates fractions of an inch per the following codes:

| Code | Fraction | Code | Fraction |
|------|----------|------|----------|
| 0- | 0 | 8- | 1/2 |
| 1- | 1/16 | 9- | 9/16 |
| 2- | 1/8 | A- | 5/8 |
| 3- | 3/16 | B- | 11/16 |
| 4- | 1/4 | C- | 3/4 |
| 5- | 5/16 | D- | 13/16 |
| 6- | 3/8 | E- | 7/8 |
| 7- | 7/16 | F- | 15/16 |

15,16 Enter applicable code for either:

Extra rod projection (“C” dimension)

First number indicates inches from 0 through 9.

Second number indicates fractions of an inch per codes shown for item 14.

- or -

Air bleed, gland drain or proximity switch location.

Item 15 indicates air bleeds (H), gland drain (G) or proximity switches (P).

Item 16 indicates location of air bleeds, gland drains or proximity switches as shown in item 10 when viewing cylinder from head end (mounting end of double rod cylinders). “-” in table indicates no air bleed or proximity switch.

| Code | Head | Cap |
|------|------|-----|
| B- | - | 1 |
| C- | - | 2 |
| D- | - | 3 |
| E- | - | 4 |
| F- | 1 | - |
| G- | 2 | - |
| H- | 3 | - |
| J- | 4 | - |
| K- | 1 | 1 |
| L- | 1 | 2 |
| M- | 1 | 3 |
| N- | 1 | 4 |
| P- | 2 | 1 |
| R- | 2 | 2 |
| S- | 2 | 3 |
| T- | 2 | 4 |
| U- | 3 | 1 |
| V- | 3 | 2 |
| W- | 3 | 3 |
| Y- | 3 | 4 |
| 1- | 4 | 1 |
| 2- | 4 | 2 |
| 3- | 4 | 3 |
| 4- | 4 | 4 |

(See detailed information on page NO TAG.)

Mounting Style

Available Mountings

The variety of standard ANSI/NFPA mountings available in the Series TZ gives you a broad selection to match the proper mount to your application. Vickers offers rigid mounts (including side lug mounts, flange mounts, and extended tie rod mounts) and swivel mounts (including clevis mounts and trunnion mounts). A guide to proper mount selection is provided on pages NO TAG through NO TAG. For custom mounts, enter "XX" for model code item 2, and give a detailed description with drawings. Series TZ cylinders are available in all mounting styles listed.

TZ01

Side lug
ANSI MS2

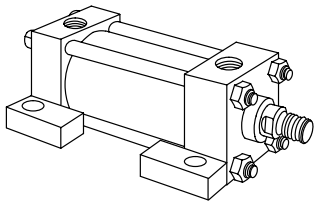

Selecting the Proper Mounting

Just as the cylinder bore must be sized to provide the proper force for an application, a cylinder mounting that can absorb these application forces must also be specified. Note: In the mounting information, some mounts have been downrated to minimize deflection. For applications where the motion is linear

and parallel to the cylinder rod motion, a rigid mount is recommended. For curvilinear motion, a swivel mount should be chosen. The specifics of each application dictate the correct mounting style.

TZ02

Side tapped
ANSI MS4

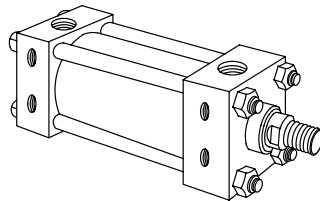

TZ04

Keyed side lug

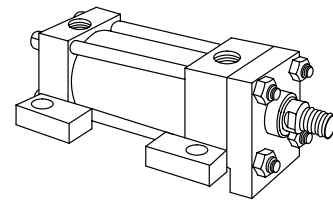

TZ05

Keyed side tapped

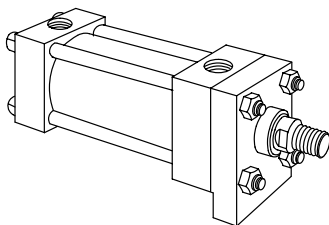

TZ07

Head rectangular flange
ANSI MF1
(Maximum working pressure 800 psi)

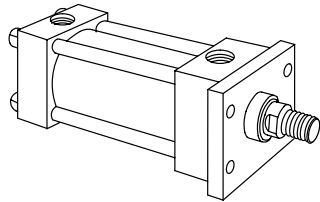

TZ08

Head square flange
ANSI MF5

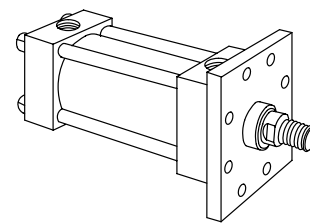

TZ09

Head rectangular
ANSI ME5

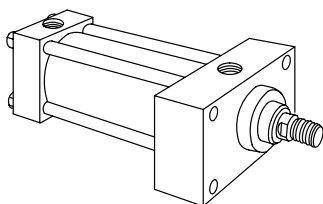

TZ10

Cap clevis
ANSI MP1

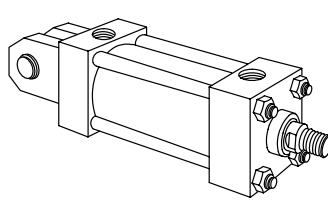

TZ12

Cap rectangular flange
ANSI MF2
(Maximum working pressure 800 psi)

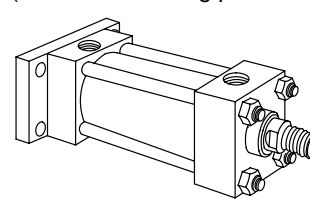

TZ13

Cap square flange
ANSI MF6

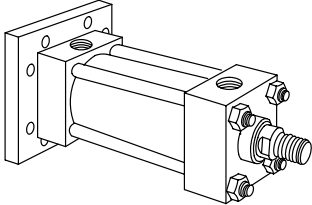

TZ14

Cap rectangular
ANSI ME6

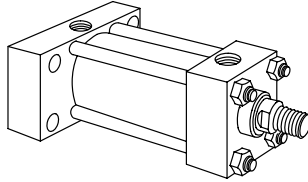

TZ15

Intermediate trunnion
ANSI MT4

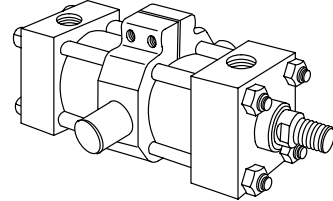

TZ16

Cap trunnion
ANSI MT2

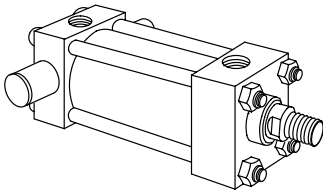

TZ17

Head trunnion
ANSI MT1

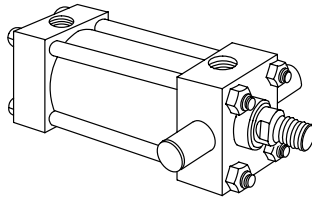

TZ19

Centerline lug
ANSI MS3

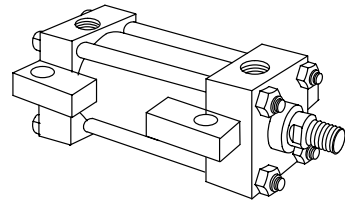

TZ21

Cap extended tie rod
ANSI MX2

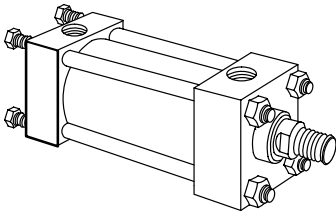

TZ22

Head extended tie rod
ANSI MX3

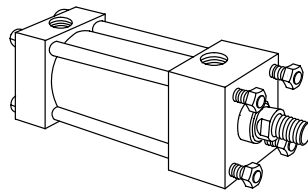

TZ23

Both ends extended tie rod
ANSI MX1

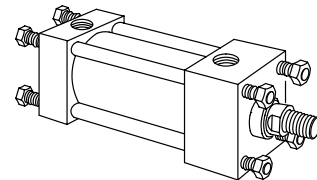

TZ24

No mount

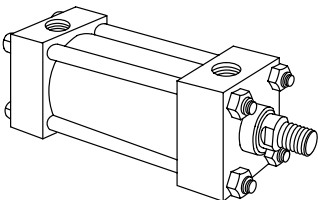

TZ25

Double rod, side lug

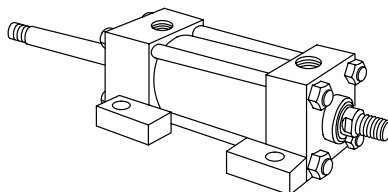

Series TZ Mounting Styles & Installation Dimensions

TZ01 Side Lug Mounts (ANSI MS2)

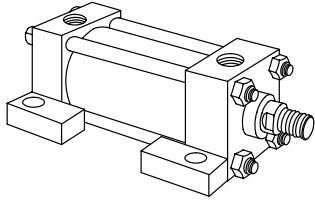

Side lug mounts are for moving loads along a flat guided surface as in a carriage along rails. The mounting surface should be flat and parallel to the centerline of the piston rod.

The load should be guided to traverse along the centerline of the piston rod.

The frame on which the cylinder is mounted must be sufficiently rigid to resist bending moments.

NOTE

Limit operating pressure to 2320 psi for minimum deflection on 6, 7 and 8 inch bores. For strokes in excess of 30 inches, see "Stop tube selection" on page NO TAG.

With unsupported loads, the bearing must absorb more force. For these applications, the larger available rod is recommended, and stop tubes should be considered.

Use high tensile socket head cap screws or hex head bolts tightened to the manufacturer's recommended torque.

For high shock applications, dowel pins or shear keys should be incorporated in the mounting design. For these applications, consider a keyed side lug mount, TZ04.

For severe side load applications, consult your local Vickers sales engineer.

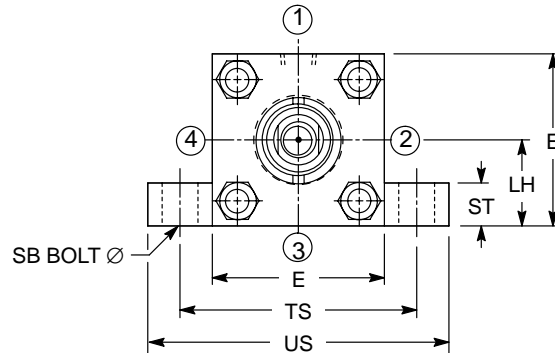
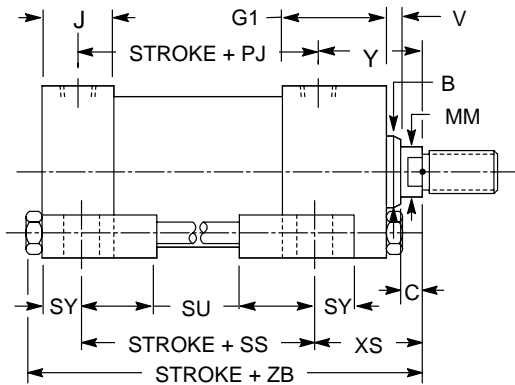

| Bore | Rod MM | ^{-0.001/0.002} B | C | E | G1 | J | V | Y | ^{-0.006/-0.010} LH | PJ+ | SB | SS+ | ST | SU | SY | TS | US | XS | Max ZB+ |
|-------|-----------|------------------------------|------|------|------|------|-----|------|--------------------------------|------|------|------|------|------|------|-------|------|------|------------|
| 1 1/2 | .625 | 1.124 | .38 | 2.50 | 2.23 | 1.48 | .25 | 2.06 | 1.25 | 2.87 | .38 | 3.88 | .50 | .91 | .39 | 3.25 | 4.00 | 1.38 | 6.00 |
| | 1 | 1.499 | .50 | 2.50 | 2.23 | 1.48 | .50 | 2.44 | 1.25 | 2.87 | .38 | 3.88 | .50 | .91 | .39 | 3.25 | 4.00 | 1.75 | 6.38 |
| 2 | 1 | 1.499 | .63 | 3.00 | 2.36 | 1.48 | .25 | 2.39 | 1.50 | 2.91 | .50 | 3.63 | .75 | 1.24 | .51 | 4.00 | 5.00 | 1.88 | 6.50 |
| | 1.375 | 1.999 | .63 | 3.00 | 2.36 | 1.48 | .38 | 2.64 | 1.50 | 2.91 | .50 | 3.63 | .75 | 1.24 | .51 | 4.00 | 5.00 | 2.13 | 6.75 |
| 2 1/2 | 1 | 1.499 | .50 | 3.50 | 2.36 | 1.48 | .25 | 2.30 | 1.75 | 3.15 | .75 | 3.38 | 1.00 | 1.56 | .68 | 4.88 | 6.25 | 2.06 | 6.63 |
| | 1.375 | 1.999 | .63 | 3.50 | 2.36 | 1.48 | .38 | 2.55 | 1.75 | 3.15 | .75 | 3.38 | 1.00 | 1.56 | .68 | 4.88 | 6.25 | 2.31 | 6.88 |
| 2 1/2 | 1.75 | 2.374 | .75 | 3.50 | 2.36 | 1.48 | .50 | 2.80 | 1.75 | 3.15 | .75 | 3.38 | 1.00 | 1.56 | .68 | 4.88 | 6.25 | 2.56 | 7.13 |
| | 2 | 2.624 | .88 | 4.50 | 2.73 | 1.73 | .38 | 3.03 | 2.25 | 3.66 | .75 | 4.13 | 1.00 | 1.55 | .69 | 5.88 | 7.25 | 2.69 | 8.13 |
| 3 1/4 | 1.375 | 1.999 | .63 | 4.50 | 2.73 | 1.73 | .25 | 2.66 | 2.50 | 3.98 | 1.00 | 4.00 | 1.25 | 2.00 | .87 | 6.75 | 8.50 | 2.31 | 7.75 |
| | 1.75 | 2.374 | .75 | 4.50 | 2.73 | 1.73 | .38 | 2.91 | 2.50 | 3.98 | 1.00 | 4.00 | 1.25 | 2.00 | .87 | 6.75 | 8.50 | 2.56 | 8.00 |
| | 2 | 2.624 | .88 | 5.00 | 2.86 | 1.73 | .38 | 3.23 | 2.50 | 3.98 | 1.00 | 4.00 | 1.25 | 2.00 | .87 | 6.75 | 8.50 | 2.69 | 8.13 |
| 4 | 1.75 | 2.374 | .75 | 5.00 | 2.86 | 1.73 | .25 | 2.85 | 3.25 | 4.64 | 1.00 | 4.50 | 1.25 | 2.00 | .87 | 8.25 | 10.0 | 2.75 | 9.00 |
| | 2 | 2.624 | .88 | 5.00 | 2.86 | 1.73 | .25 | 2.98 | 3.25 | 4.64 | 1.00 | 4.50 | 1.25 | 2.00 | .87 | 8.25 | 10.0 | 2.88 | 9.25 |
| | 2.5 | 3.124 | 1.00 | 5.00 | 2.86 | 1.73 | .38 | 3.23 | 3.25 | 4.64 | 1.00 | 4.50 | 1.25 | 2.00 | .87 | 8.25 | 10.0 | 3.13 | 9.25 |
| | 3 | 3.749 | 1.00 | 5.00 | 2.86 | 1.73 | .38 | 3.06 | 3.25 | 4.64 | 1.00 | 4.50 | 1.25 | 2.00 | .87 | 8.25 | 10.0 | 3.13 | 9.25 |
| 5 | 2 | 2.624 | .88 | 6.50 | 2.98 | 1.73 | .25 | 2.82 | 3.75 | 5.36 | 1.25 | 5.13 | 1.50 | 2.50 | 1.12 | 9.75 | 12.0 | 2.88 | 10.63 |
| | 2.5 | 3.124 | 1.00 | 6.50 | 2.98 | 1.73 | .38 | 3.06 | 3.75 | 5.36 | 1.25 | 5.13 | 1.50 | 2.50 | 1.12 | 9.75 | 12.0 | 3.13 | 11.88 |
| | 3 | 3.749 | 1.00 | 6.50 | 2.98 | 1.73 | .38 | 3.06 | 3.75 | 5.36 | 1.25 | 5.13 | 1.50 | 2.50 | 1.12 | 9.75 | 12.0 | 3.13 | 11.88 |
| | 3.5 | 4.249 | 1.00 | 6.50 | 2.98 | 1.73 | .38 | 3.06 | 3.75 | 5.36 | 1.25 | 5.13 | 1.50 | 2.50 | 1.12 | 9.75 | 12.0 | 3.13 | 11.88 |
| 6 | 2.5 | 3.124 | 1.00 | 7.50 | 3.23 | 2.23 | .25 | 3.22 | 4.25 | 5.83 | 1.50 | 5.75 | 1.75 | 2.88 | 1.37 | 11.25 | 14.0 | 3.63 | 11.88 |
| | 3 | 3.749 | 1.00 | 7.50 | 3.23 | 2.23 | .25 | 3.22 | 4.25 | 5.83 | 1.50 | 5.75 | 1.75 | 2.88 | 1.37 | 11.25 | 14.0 | 3.63 | 11.88 |
| | 3.5 | 4.249 | 1.00 | 7.50 | 3.23 | 2.23 | .25 | 3.22 | 4.25 | 5.83 | 1.50 | 5.75 | 1.75 | 2.88 | 1.37 | 11.25 | 14.0 | 3.63 | 11.88 |
| | 4 | 4.749 | 1.00 | 7.50 | 3.23 | 2.23 | .25 | 3.22 | 4.25 | 5.83 | 1.50 | 5.75 | 1.75 | 2.88 | 1.37 | 11.25 | 14.0 | 3.63 | 11.88 |
| | 4.5 | 5.249 | 1.00 | 7.50 | 3.23 | 2.23 | .25 | 3.22 | 4.25 | 5.83 | 1.50 | 5.75 | 1.75 | 2.88 | 1.37 | 11.25 | 14.0 | 3.63 | 11.88 |
| 7 | 3.5 | 4.249 | 1.00 | 8.50 | 3.73 | 2.73 | .25 | 3.60 | 4.75 | 6.50 | 1.50 | 6.75 | 1.75 | 2.88 | 1.37 | 12.25 | 15.0 | 3.63 | 13.00 |
| | 4 | 4.749 | 1.00 | 8.50 | 3.73 | 2.73 | .25 | 3.60 | 4.75 | 6.50 | 1.50 | 6.75 | 1.75 | 2.88 | 1.37 | 12.25 | 15.0 | 3.63 | 13.00 |
| | 4.5 | 5.249 | 1.00 | 8.50 | 3.73 | 2.73 | .25 | 3.60 | 4.75 | 6.50 | 1.50 | 6.75 | 1.75 | 2.88 | 1.37 | 12.25 | 15.0 | 3.63 | 13.00 |
| | 5 | 5.749 | 1.00 | 8.50 | 3.73 | 2.73 | .25 | 3.60 | 4.75 | 6.50 | 1.50 | 6.75 | 1.75 | 2.88 | 1.37 | 12.25 | 15.0 | 3.63 | 13.00 |
| | 5.5 | 6.249 | 1.00 | 8.50 | 3.73 | 2.73 | .25 | 3.60 | 4.75 | 6.50 | 1.50 | 6.75 | 1.75 | 2.88 | 1.37 | 12.25 | 15.0 | 3.63 | 13.00 |

+ Plus stroke

TZ02 Tapped (ANSI MS4)

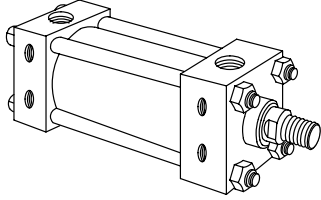

Tapped mounts are for moving loads along a flat guided surface as in a carriage along rails.

The mounting surface should be flat and parallel to the centerline of the piston rod.

The load should be guided to traverse along the centerline of the piston rod.

The frame on which the cylinder is mounted must be sufficiently rigid to resist bending moments.

NOTE

For strokes in excess of 30 inches, see "Stop tube selection" on page NO TAG.

With unsupported loads, the bearing must absorb more force. For these applications, the larger available rod is

recommended, and stop tubes should be considered.

Use high tensile socket head cap screws or hex head bolts tightened to the manufacturer's recommended torque.

For high shock applications, dowel pins or shear keys should be incorporated in the mounting design. For these applications, consider a keyed side lug mount, TZ04.

For severe side load applications, consult your local Vickers sales engineer.

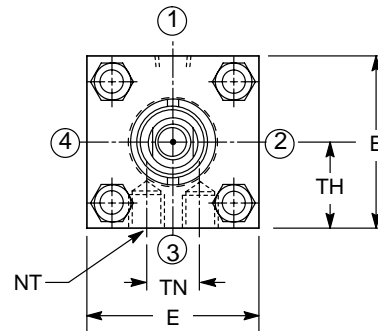
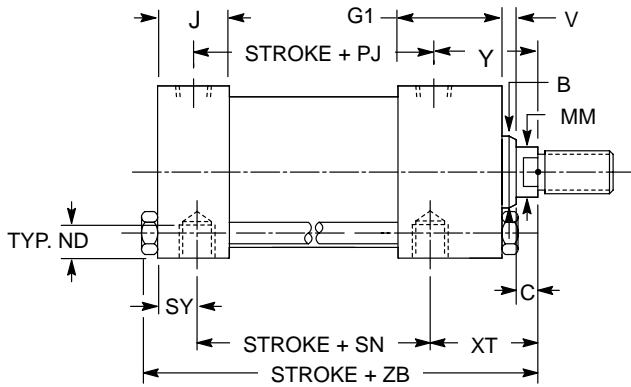

| Bore | Rod MM | ^{-.0001-.002} B | C | E | G1 | J | V | Y | Min. ND | NT | PJ+ | SN+ | ^{-.006/-010} TH | TN | SY | XT | Max ZB+ | | | | | | | | | | | | | |
|-------|-----------|-----------------------------|------|------|------|------|-----|------|------------|-----------|------|------|-----------------------------|------|------|------|------------|------|------|------|------|------|-----------|------|------|------|------|-----|------|-------|
| 1 1/2 | .625 | 1.124 | .38 | 2.50 | 2.23 | 1.48 | .25 | 2.06 | .37 | 3/8 - 16 | 2.87 | 2.88 | 1.25 | .75 | .31 | 2.00 | 6.00 | | | | | | | | | | | | | |
| | 1 | 1.499 | .50 | 2.50 | 2.23 | 1.48 | .50 | 2.44 | .37 | | 2.87 | 2.88 | 1.25 | .75 | .31 | 2.38 | 6.38 | | | | | | | | | | | | | |
| 2 | 1 | 1.499 | .50 | 3.00 | 2.36 | 1.48 | .25 | 2.39 | .49 | 1/2 - 13 | 2.91 | 2.88 | 1.50 | .94 | .39 | 2.38 | 6.50 | | | | | | | | | | | | | |
| | 1.375 | 1.999 | .63 | 3.00 | 2.36 | 1.48 | .38 | 2.64 | .49 | | 2.91 | 2.88 | 1.50 | .94 | .39 | 2.63 | 6.75 | | | | | | | | | | | | | |
| 2 1/2 | 1 | 1.499 | .50 | 3.50 | 2.36 | 1.48 | .25 | 2.30 | .61 | 5/8 - 11 | 3.15 | 3.00 | 1.75 | 1.31 | .39 | 2.38 | 6.63 | | | | | | | | | | | | | |
| | 1.375 | 1.999 | .63 | | | | .38 | 2.55 | | | | | | | | .50 | 2.80 | 2.63 | 6.88 | | | | | | | | | | | |
| | 1.75 | 2.374 | .75 | | | | .25 | 2.66 | | | | | | | | .25 | 2.80 | 2.88 | 7.13 | | | | | | | | | | | |
| 3 1/4 | 1.375 | 1.999 | .63 | 4.50 | 2.73 | 1.73 | .25 | 2.66 | .75 | 3/4 - 10 | 3.66 | 3.50 | 2.25 | 1.50 | .47 | 2.75 | 7.75 | | | | | | | | | | | | | |
| | 1.75 | 2.374 | .75 | | | | .38 | 2.91 | | | | | | | | .38 | 3.03 | 3.00 | 8.00 | | | | | | | | | | | |
| | 2 | 2.624 | .88 | | | | .25 | 2.85 | | | | | | | | .25 | 3.23 | 3.13 | 8.13 | | | | | | | | | | | |
| 4 | 1.75 | 2.374 | .75 | 5.00 | 2.86 | 1.73 | .25 | 2.85 | .63 | 1 - 8 | 3.98 | 3.75 | 2.50 | 2.06 | .67 | 3.00 | 8.25 | | | | | | | | | | | | | |
| | 2 | 2.624 | .88 | | | | .25 | 2.98 | | | | | | | | .25 | 3.23 | 3.13 | 8.38 | | | | | | | | | | | |
| | 2.5 | 3.124 | 1.00 | | | | .38 | 3.06 | | | | | | | | .38 | 3.23 | 3.38 | 8.63 | | | | | | | | | | | |
| 5 | 2 | 2.624 | .88 | 6.50 | 2.98 | 1.73 | .25 | 2.82 | 1.00 | 1 - 8 | 4.61 | 4.25 | 3.25 | 2.94 | .67 | 3.13 | 9.00 | | | | | | | | | | | | | |
| | 2.5 | 3.124 | 1.00 | | | | .38 | 3.06 | | | | | | | | .38 | 3.06 | 3.38 | 9.25 | | | | | | | | | | | |
| | 3 | 3.749 | 1.00 | | | | .38 | 3.06 | | | | | | | | .38 | 3.06 | 3.38 | 9.25 | | | | | | | | | | | |
| | 3.5 | 4.249 | 1.00 | | | | .38 | 3.06 | | | | | | | | .38 | 3.06 | 3.38 | 9.25 | | | | | | | | | | | |
| 6 | 2.5 | 3.124 | .88 | 7.50 | 3.23 | 2.23 | .25 | 3.22 | 1.25 | 1 1/4 - 7 | 4.88 | 5.13 | 3.75 | 3.31 | .87 | 3.50 | 10.63 | | | | | | | | | | | | | |
| | 3 | 3.749 | 1.00 | | | | | | | | | | | | | | | 1.50 | 1.50 | 1.50 | 1.50 | 1.12 | | | | | | | | |
| | 3.5 | 4.249 | 1.00 | | | | | | | | | | | | | | | | | | | | 1 1/2 - 6 | 5.38 | 5.88 | 4.25 | 3.75 | .87 | 3.81 | 11.88 |
| | 4 | 4.749 | 1.00 | | | | | | | | | | | | | | | | | | | | | | | | | | | |
| 4.5 | 5.249 | 1.00 | | | | | | | | | | | | | | | | | | | | | | | | | | | | |
| 5 | 5.749 | 1.00 | | | | | | | | | | | | | | | | | | | | | | | | | | | | |
| 8 | 3.5 | 4.249 | .88 | 9.63 | 4.23 | 2.98 | .25 | 3.86 | 1.50 | 1 1/2 - 6 | 6.50 | 6.63 | 4.75 | 4.25 | 1.14 | 3.94 | 13.00 | | | | | | | | | | | | | |
| | 4 | 4.749 | 1.00 | | | | | | | | | | | | | | | | | | | | | | | | | | | |
| | 4.5 | 5.249 | 1.00 | | | | | | | | | | | | | | | | | | | | | | | | | | | |
| | 5 | 5.749 | 1.00 | | | | | | | | | | | | | | | | | | | | | | | | | | | |
| | 5.5 | 6.249 | 1.00 | | | | | | | | | | | | | | | | | | | | | | | | | | | |

+ Plus stroke

TZ04 Keyed Side Lug Mounts

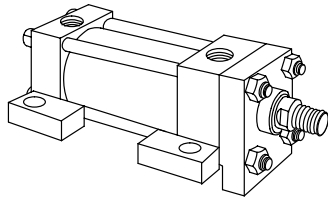

Keyed side lug mounts are for moving loads along a flat guided surface as in a carriage along rails.

The mounting surface should be flat and parallel to the centerline of the piston rod.

The load should be guided to traverse along the centerline of the piston rod.

The frame on which the cylinder is mounted must be sufficiently rigid to resist bending moments.

NOTE

For strokes in excess of 30 inches, see "Stop tube selection" on page NO TAG.

With unsupported loads, the bearing must absorb more force. For these applications, the larger available rod is recommended, and stop tubes should be considered.

Use high tensile socket head cap screws or hex head bolts tightened to the manufacturer's recommended torque.

For severe side load applications, consult your local Vickers sales engineer.

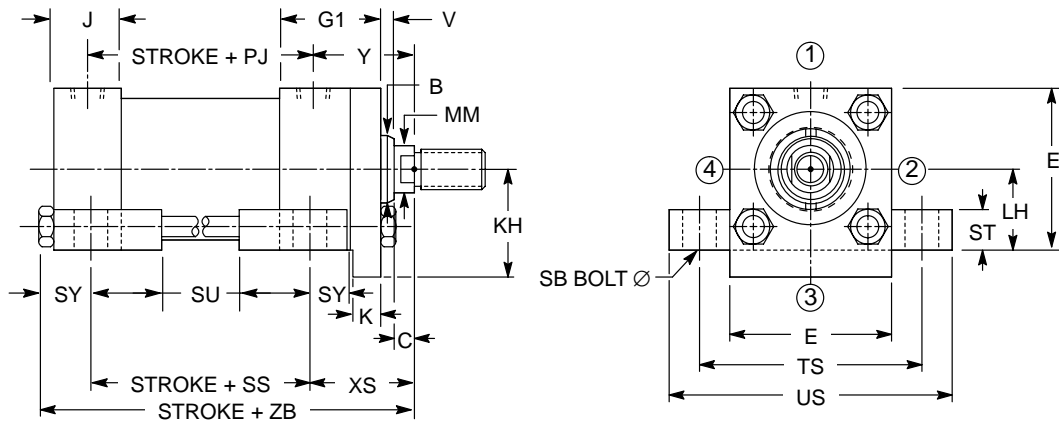

| Bore | Rod MM | ^{-0.001/-0.002} B | C | E | G1 | J | ^{+0.001/-0.002} K | V | Y | Max KH | ^{-0.006/-0.010} LH | PJ+ | SB | SS+ | ST | SU | SY | TS | US | XS | Max ZB+ |
|-------|--------|----------------------------|-----|------|------|------|----------------------------|-----|------|--------|-----------------------------|------|-----|------|------|------|------|------|------|------|---------|
| 1 1/2 | .625 | 1.124 | .38 | 2.50 | 2.23 | 1.48 | .312 | .25 | 2.06 | 1.44 | 1.25 | 2.87 | .38 | 3.88 | .50 | .91 | .39 | 3.25 | 4.00 | 1.38 | 6.00 |
| | 1 | 1.499 | .50 | 2.50 | 2.23 | 1.48 | .312 | .50 | 2.44 | 1.44 | 1.25 | 2.87 | .38 | 3.88 | .50 | .91 | .39 | 3.25 | 4.00 | 1.75 | 6.38 |
| 2 | 1 | 1.499 | .50 | 3.00 | 2.36 | 1.48 | .562 | .25 | 2.39 | 1.81 | 1.50 | 2.91 | .50 | 3.63 | .75 | 1.24 | .51 | 4.00 | 5.00 | 1.88 | 6.50 |
| | 1.375 | 1.999 | .63 | 3.00 | 2.36 | 1.48 | .562 | .38 | 2.64 | 1.81 | 1.50 | 2.91 | .50 | 3.63 | .75 | 1.24 | .51 | 4.00 | 5.00 | 2.13 | 6.75 |
| 2 1/2 | 1 | 1.499 | .50 | 3.50 | 2.36 | 1.48 | .562 | .25 | 2.30 | 2.06 | 1.75 | 3.15 | .75 | 3.38 | 1.00 | 1.56 | .68 | 4.88 | 6.25 | 2.06 | 6.63 |
| | 1.375 | 1.999 | .63 | 3.50 | 2.36 | 1.48 | .562 | .38 | 2.55 | 2.06 | 1.75 | 3.15 | .75 | 3.38 | 1.00 | 1.56 | .68 | 4.88 | 6.25 | 2.31 | 6.88 |
| 3 1/4 | 1.75 | 2.374 | .75 | 4.50 | 2.73 | 1.73 | .687 | .25 | 2.66 | 2.63 | 2.25 | 3.66 | .75 | 4.13 | 1.00 | 1.55 | .69 | 5.88 | 7.25 | 2.56 | 7.13 |
| | 2 | 2.624 | .88 | 4.50 | 2.73 | 1.73 | .687 | .38 | 2.91 | 2.63 | 2.25 | 3.66 | .75 | 4.13 | 1.00 | 1.55 | .69 | 5.88 | 7.25 | 2.56 | 7.13 |
| 4 | 1.75 | 2.374 | .75 | 5.00 | 2.86 | 1.73 | .812 | .25 | 2.85 | 2.94 | 2.50 | 3.98 | 1.0 | 4.00 | 1.25 | 2.00 | .87 | 6.75 | 8.50 | 2.75 | 8.25 |
| | 2 | 2.624 | .88 | 5.00 | 2.86 | 1.73 | .812 | .38 | 2.98 | 2.94 | 2.50 | 3.98 | 1.0 | 4.00 | 1.25 | 2.00 | .87 | 6.75 | 8.50 | 2.88 | 8.38 |
| | 2.5 | 3.124 | 1.0 | 5.00 | 2.86 | 1.73 | .812 | .38 | 3.23 | 2.94 | 2.50 | 3.98 | 1.0 | 4.00 | 1.25 | 2.00 | .87 | 6.75 | 8.50 | 3.13 | 8.63 |
| 5 | 2 | 2.624 | .88 | 6.50 | 2.98 | 1.73 | .812 | .25 | 3.14 | 3.68 | 3.25 | 4.61 | 1.0 | 4.50 | 1.25 | 2.00 | .87 | 8.25 | 10.0 | 2.88 | 9.00 |
| | 2.5 | 3.124 | 1.0 | 6.50 | 2.98 | 1.73 | .812 | .38 | 3.39 | 3.68 | 3.25 | 4.61 | 1.0 | 4.50 | 1.25 | 2.00 | .87 | 8.25 | 10.0 | 3.13 | 9.25 |
| | 3 | 3.749 | 1.0 | 6.50 | 2.98 | 1.73 | .812 | .38 | 3.39 | 3.68 | 3.25 | 4.61 | 1.0 | 4.50 | 1.25 | 2.00 | .87 | 8.25 | 10.0 | 3.13 | 9.25 |
| | 3.5 | 4.249 | 1.0 | 6.50 | 2.98 | 1.73 | .812 | .38 | 3.39 | 3.68 | 3.25 | 4.61 | 1.0 | 4.50 | 1.25 | 2.00 | .87 | 8.25 | 10.0 | 3.13 | 9.25 |
| 6 | 2.5 | 3.124 | 1.0 | 7.50 | 3.23 | 2.23 | .937 | .25 | 3.50 | 4.25 | 3.75 | 4.88 | 1.3 | 5.13 | 1.50 | 2.50 | 1.12 | 9.75 | 12.0 | 3.38 | 10.63 |
| | 3 | 3.749 | 1.0 | 7.50 | 3.23 | 2.23 | .937 | .25 | 3.50 | 4.25 | 3.75 | 4.88 | 1.3 | 5.13 | 1.50 | 2.50 | 1.12 | 9.75 | 12.0 | 3.38 | 10.63 |
| | 3.5 | 4.249 | 1.0 | 7.50 | 3.23 | 2.23 | .937 | .25 | 3.50 | 4.25 | 3.75 | 4.88 | 1.3 | 5.13 | 1.50 | 2.50 | 1.12 | 9.75 | 12.0 | 3.38 | 10.63 |
| | 4 | 4.749 | 1.0 | 7.50 | 3.23 | 2.23 | .937 | .25 | 3.50 | 4.25 | 3.75 | 4.88 | 1.3 | 5.13 | 1.50 | 2.50 | 1.12 | 9.75 | 12.0 | 3.38 | 10.63 |
| 7 | 3 | 3.749 | 1.0 | 8.50 | 3.73 | 2.73 | .937 | .25 | 3.81 | 4.75 | 4.25 | 5.38 | 1.5 | 5.75 | 1.75 | 2.88 | 1.37 | 11.3 | 14.0 | 3.63 | 11.88 |
| | 3.5 | 4.249 | 1.0 | 8.50 | 3.73 | 2.73 | .937 | .25 | 3.81 | 4.75 | 4.25 | 5.38 | 1.5 | 5.75 | 1.75 | 2.88 | 1.37 | 11.3 | 14.0 | 3.63 | 11.88 |
| | 4 | 4.749 | 1.0 | 8.50 | 3.73 | 2.73 | .937 | .25 | 3.81 | 4.75 | 4.25 | 5.38 | 1.5 | 5.75 | 1.75 | 2.88 | 1.37 | 11.3 | 14.0 | 3.63 | 11.88 |
| | 4.5 | 5.249 | 1.0 | 8.50 | 3.73 | 2.73 | .937 | .25 | 3.81 | 4.75 | 4.25 | 5.38 | 1.5 | 5.75 | 1.75 | 2.88 | 1.37 | 11.3 | 14.0 | 3.63 | 11.88 |
| 8 | 3.5 | 4.249 | 1.0 | 9.63 | 4.23 | 2.98 | .937 | .25 | 3.86 | 5.25 | 4.75 | 6.50 | 1.5 | 6.75 | 1.75 | 2.88 | 1.37 | 12.3 | 15.0 | 3.63 | 13.00 |
| | 4 | 4.749 | 1.0 | 9.63 | 4.23 | 2.98 | .937 | .25 | 3.86 | 5.25 | 4.75 | 6.50 | 1.5 | 6.75 | 1.75 | 2.88 | 1.37 | 12.3 | 15.0 | 3.63 | 13.00 |
| | 4.5 | 5.249 | 1.0 | 9.63 | 4.23 | 2.98 | .937 | .25 | 3.86 | 5.25 | 4.75 | 6.50 | 1.5 | 6.75 | 1.75 | 2.88 | 1.37 | 12.3 | 15.0 | 3.63 | 13.00 |
| | 5 | 5.749 | 1.0 | 9.63 | 4.23 | 2.98 | .937 | .25 | 3.86 | 5.25 | 4.75 | 6.50 | 1.5 | 6.75 | 1.75 | 2.88 | 1.37 | 12.3 | 15.0 | 3.63 | 13.00 |

+ Plus stroke

TZ05 Keyed Tapped

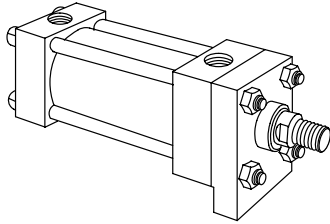

Tapped mounts are for moving loads along a flat guided surface as in a carriage along rails.

The mounting surface should be flat and parallel to the centerline of the piston rod.

The load should be guided to traverse along the centerline of the piston rod.

The frame on which the cylinder is mounted must be sufficiently rigid to resist bending moments.

NOTE

For strokes in excess of 30 inches, see "Stop tube selection" on page NO TAG.

With unsupported loads, the bearing must absorb more force. For these applications, the larger available rod is

recommended, and stop tubes should be considered.

Use high tensile socket head cap screws or hex head bolts tightened to the manufacturer's recommended torque.

For high shock applications, dowel pins or shear keys should be incorporated in the mounting design. For these applications, consider a keyed side lug mount, TZ04.

For severe side load applications, consult your local Vickers sales engineer.

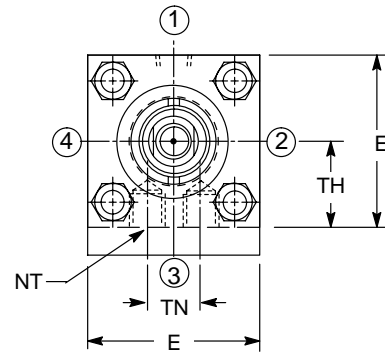
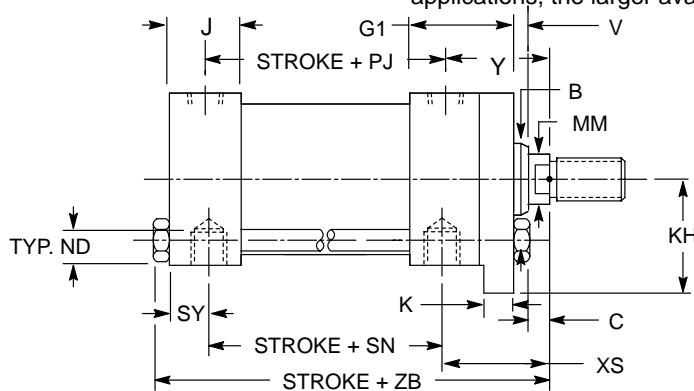

| Bore | Rod MM | ^{-0.004-.002} B | C | E | G1 | J | ^{+0.000/-0.002} K | V | Y | Max KH | Min. ND | NT | PJ+ | SN+ | ^{-0.006-.010} TH | TN | SY | XS | Max ZB+ |
|-------|--------|--------------------------|------|------|------|------|----------------------------|-----|------|--------|---------|-----------|------|------|---------------------------|------|------|------|---------|
| 1 1/2 | .625 | 1.124 | .38 | 2.50 | 2.23 | 1.48 | .312 | .25 | 2.06 | 1.44 | .37 | 3/8 - 16 | 2.87 | 2.88 | 1.25 | .75 | .31 | 2.00 | 6.00 |
| | 1 | 1.499 | .50 | 2.50 | 2.23 | 1.48 | .312 | .50 | 2.44 | 1.44 | .37 | 3/8 - 16 | 2.87 | 2.88 | 1.25 | .75 | .31 | 2.38 | 6.38 |
| 2 | 1 | 1.499 | .50 | 3.00 | 2.36 | 1.48 | .562 | .25 | 2.39 | 1.81 | .49 | 1/2 - 13 | 2.91 | 2.88 | 1.50 | .94 | .39 | 2.38 | 6.50 |
| | 1.375 | 1.999 | .63 | 3.00 | 2.36 | 1.48 | .562 | .38 | 2.64 | 1.81 | .49 | 1/2 - 13 | 2.91 | 2.88 | 1.50 | .94 | .39 | 2.63 | 6.75 |
| 2 1/2 | 1 | 1.499 | .50 | 3.50 | 2.36 | 1.48 | .562 | .25 | 2.30 | 2.06 | .61 | 5/8 - 11 | 3.15 | 3.00 | 1.75 | 1.31 | .39 | 2.38 | 6.63 |
| | 1.375 | 1.999 | .63 | 3.50 | 2.36 | 1.48 | .562 | .38 | 2.55 | 2.06 | .61 | 5/8 - 11 | 3.15 | 3.00 | 1.75 | 1.31 | .39 | 2.63 | 6.88 |
| 3 1/4 | 1.75 | 1.999 | .63 | 4.50 | 2.73 | 1.73 | .687 | .25 | 2.66 | 2.63 | .75 | 3/4 - 10 | 3.66 | 3.50 | 2.25 | 1.50 | .47 | 2.75 | 7.75 |
| | 2 | 2.624 | .88 | 4.50 | 2.73 | 1.73 | .687 | .38 | 2.91 | 2.63 | .75 | 3/4 - 10 | 3.66 | 3.50 | 2.25 | 1.50 | .47 | 3.00 | 8.00 |
| 4 | 1.75 | 2.374 | .75 | 5.00 | 2.86 | 1.73 | .812 | .25 | 2.85 | 2.94 | .63 | 1 - 8 | 3.98 | 3.75 | 2.50 | 2.06 | .67 | 3.13 | 8.38 |
| | 2 | 2.624 | .88 | 5.00 | 2.86 | 1.73 | .812 | .25 | 2.98 | 2.94 | .63 | 1 - 8 | 3.98 | 3.75 | 2.50 | 2.06 | .67 | 3.38 | 8.63 |
| 5 | 2 | 2.624 | .88 | 6.50 | 2.98 | 1.73 | .812 | .25 | 2.82 | 3.68 | 1.00 | 1 - 8 | 4.61 | 4.25 | 3.25 | 2.94 | .67 | 3.13 | 9.00 |
| | 2.5 | 3.124 | 1.00 | 6.50 | 2.98 | 1.73 | .812 | .38 | 3.06 | 3.68 | 1.00 | 1 - 8 | 4.61 | 4.25 | 3.25 | 2.94 | .67 | 3.38 | 9.25 |
| 6 | 3 | 3.749 | 1.00 | 7.50 | 3.23 | 2.23 | .937 | .25 | 3.22 | 4.25 | 1.25 | 1 1/4 - 7 | 4.88 | 5.13 | 3.75 | 3.31 | .87 | 3.50 | 10.63 |
| | 3.5 | 4.249 | 1.00 | 7.50 | 3.23 | 2.23 | .937 | .25 | 3.22 | 4.25 | 1.25 | 1 1/4 - 7 | 4.88 | 5.13 | 3.75 | 3.31 | .87 | 3.50 | 10.63 |
| 7 | 3 | 3.749 | 1.00 | 8.50 | 3.73 | 2.73 | .937 | .25 | 3.60 | 4.75 | 1.50 | 1 1/2 - 6 | 5.38 | 5.88 | 4.25 | 3.75 | .87 | 3.81 | 11.88 |
| | 3.5 | 4.249 | 1.00 | 8.50 | 3.73 | 2.73 | .937 | .25 | 3.60 | 4.75 | 1.50 | 1 1/2 - 6 | 5.38 | 5.88 | 4.25 | 3.75 | .87 | 3.81 | 11.88 |
| 8 | 4 | 4.749 | 1.00 | 9.63 | 4.23 | 2.98 | .937 | .25 | 3.86 | 5.25 | 1.50 | 1 1/2 - 6 | 6.50 | 6.63 | 4.75 | 4.25 | 1.14 | 3.94 | 13.00 |
| | 4.5 | 5.249 | 1.00 | 9.63 | 4.23 | 2.98 | .937 | .25 | 3.86 | 5.25 | 1.50 | 1 1/2 - 6 | 6.50 | 6.63 | 4.75 | 4.25 | 1.14 | 3.94 | 13.00 |

+ Plus stroke

TZ07 Head Rectangular Mounts (ANSI MF1)

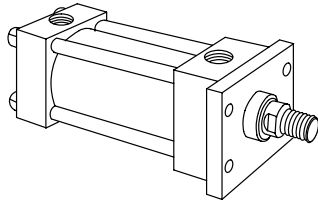

These mounts are ideal for straight line force transfer applications in which the

cylinder is used in tension (pulling). The mounting surface should be flat, and the rod end cartridge should be piloted into it.

The frame on which the cylinder is mounted must be sufficiently rigid to resist bending moments.

NOTE

For strokes in excess of 30 inches, see "Stop tube selection" on page NO TAG.

The force of the load should be perpendicular to the mounting surface

and parallel to the centerline of the piston rod. For eccentric loads, the larger of the two available rods in each bore size is recommended. Stop tubes should also be considered.

The head rectangular mounts (TZ09) is recommended for heavy duty applications. TZ07 mounts are only rated for a maximum of 800 psi (55 bar) on the push stroke.

Use high tensile socket head cap screws or hex head bolts tightened to the manufacturer's recommended torque.

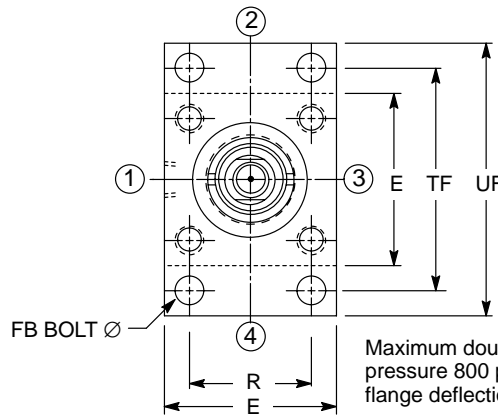
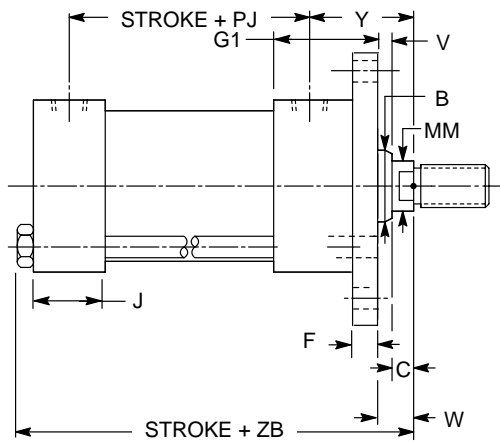

Maximum double acting working pressure 800 psi – for minimum flange deflection.

| Bore | Rod MM | ^{-0.001-0.002} B | C | E | F | G1 | J | R | V | W | Y | FB | PJ+ | TF | UF | Max ZB+ |
|-------|--------|---------------------------|------|------|------|------|------|------|------|------|------|------|------|-------|-------|---------|
| 1 1/2 | .625 | 1.124 | .38 | 2.50 | .38 | 2.23 | 1.48 | 1.63 | .25 | .63 | 2.06 | .38 | 2.87 | 3.44 | 4.25 | 6.00 |
| | 1 | 1.499 | .50 | 2.50 | .38 | 2.23 | 1.48 | 1.63 | .50 | 1.00 | 2.44 | .38 | 2.87 | 3.44 | 4.25 | 6.38 |
| 2 | 1 | 1.499 | .50 | 3.00 | .63 | 2.36 | 1.48 | 2.05 | .25 | .75 | 2.39 | .50 | 2.91 | 4.13 | 5.13 | 6.50 |
| | 1.375 | 1.999 | .63 | 3.00 | .63 | 2.36 | 1.48 | 2.05 | .38 | 1.00 | 2.64 | .50 | 2.91 | 4.13 | 5.13 | 6.75 |
| 2 1/2 | 1 | 1.499 | .50 | 3.50 | .63 | 2.36 | 1.48 | 2.55 | .25 | .75 | 2.30 | .50 | 3.15 | 4.63 | 5.63 | 6.63 |
| | 1.375 | 1.999 | .63 | | | | | | 2.55 | 1.00 | 2.55 | | | | | 6.88 |
| | 1.75 | 2.374 | .75 | | | | | | .50 | 1.25 | 2.80 | | | | | 7.13 |
| 3 1/4 | 1.375 | 1.999 | .63 | 4.50 | .75 | 2.73 | 1.73 | 3.25 | .25 | .88 | 2.66 | .63 | 3.66 | 5.88 | 7.13 | 7.75 |
| | 1.75 | 2.374 | .75 | | | | | | .38 | 1.13 | 2.91 | | | | | 8.00 |
| | 2 | 2.624 | .88 | | | | | | .38 | 1.25 | 3.03 | | | | | 8.13 |
| 4 | 1.75 | 2.374 | .75 | 5.00 | .88 | 2.86 | 1.73 | 3.82 | .25 | 1.00 | 2.85 | .63 | 3.98 | 6.38 | 7.63 | 8.25 |
| | 2 | 2.624 | .88 | | | | | | .25 | 1.13 | 2.98 | | | | | 8.38 |
| | 2.5 | 3.124 | 1.00 | | | | | | .38 | 1.38 | 3.23 | | | | | 8.63 |
| 5 | 2 | 2.624 | .88 | 6.50 | .88 | 2.98 | 1.73 | 4.95 | .25 | 1.13 | 3.14 | .88 | 4.61 | 8.19 | 9.75 | 9.00 |
| | 2.5 | 3.124 | 1.00 | | | | | | .38 | 1.38 | 3.39 | | | | | 9.25 |
| | 3 | 3.749 | 1.00 | | | | | | .38 | 1.38 | 3.39 | | | | | 9.25 |
| | 3.5 | 4.249 | 1.00 | | | | | | .38 | 1.38 | 3.39 | | | | | 9.25 |
| 6 | 2.5 | 3.124 | 1.00 | 7.50 | 1.00 | 3.23 | 2.23 | 5.73 | .25 | 1.25 | 3.50 | 1.00 | 4.88 | 9.44 | 11.25 | 10.63 |
| | 3 | 3.749 | | | | | | | | | | | | | | |
| | 3.5 | 4.249 | | | | | | | | | | | | | | |
| | 4 | 4.749 | | | | | | | | | | | | | | |
| 7 | 3 | 3.749 | 1.00 | 8.50 | 1.00 | 3.73 | 2.73 | 6.58 | .25 | 1.25 | 3.81 | 1.13 | 5.38 | 10.63 | 12.63 | 11.88 |
| | 3.5 | 4.249 | | | | | | | | | | | | | | |
| | 4 | 4.749 | | | | | | | | | | | | | | |
| | 4.5 | 5.249 | | | | | | | | | | | | | | |
| | 5 | 5.749 | | | | | | | | | | | | | | |
| 8 | 3.5 | 4.249 | 1.00 | 9.63 | 1.00 | 4.23 | 2.98 | 7.50 | .25 | 1.25 | 3.86 | 1.25 | 6.50 | 11.81 | 14.00 | 13.00 |
| | 4 | 4.749 | | | | | | | | | | | | | | |
| | 4.5 | 5.249 | | | | | | | | | | | | | | |
| | 5 | 5.749 | | | | | | | | | | | | | | |
| | 5.5 | 6.249 | | | | | | | | | | | | | | |

TZ08 Head Square Flange (ANSI MF5)

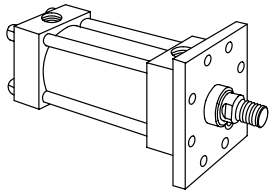

These mounts are ideal for straight line force transfer applications in which the cylinder is used in tension (pulling).

The mounting surface should be flat, and the rod end cartridge should be piloted into it.

The frame on which the cylinder is mounted must be sufficiently rigid to resist bending moments.

NOTE

For strokes in excess of 30 inches, see "Stop tube selection" on page NO TAG.

The force of the load should be perpendicular to the mounting surface and parallel to the centerline of the

piston rod. For eccentric loads, the larger of the two available rods in each bore size is recommended. Stop tubes should also be considered.

The head rectangular mounts (TZ09) is recommended for heavy duty applications. Seven and eight inch bore TZ08 mounts are only rated for a maximum of 1500 psi (105 bar) on the push stroke.

Use high tensile socket head cap screws or hex head bolts tightened to the manufacturer's recommended torque.

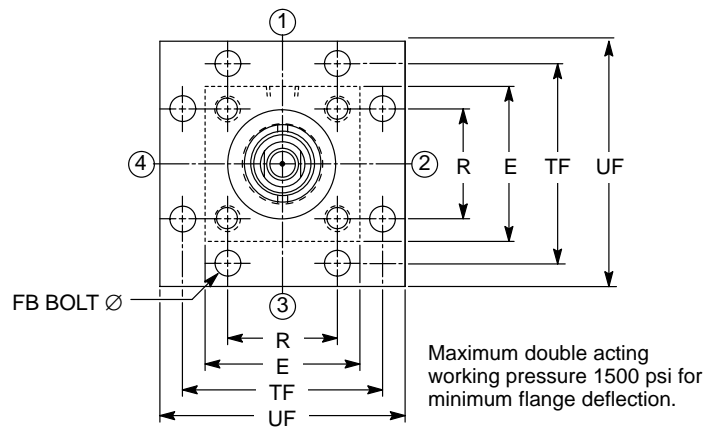
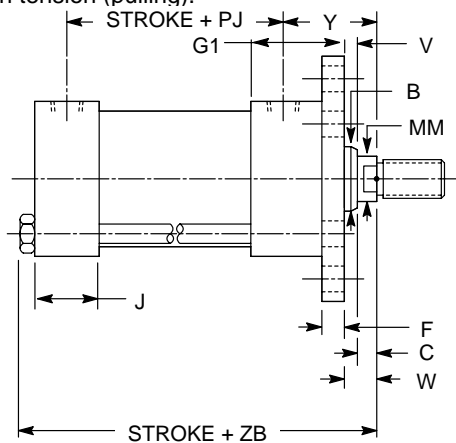

| Bore | Rod MM | ^{-0.001/-0.002} B | C | E | F | G1 | J | R | V | W | Y | FB | PJ+ | TF | UF | Max ZB+ |
|-------|-----------|-------------------------------|------|------|------|------|------|------|------|------|-------|------|------|-------|-------|------------|
| 1 1/2 | .625 | 1.124 | .38 | 2.50 | .38 | 2.23 | 1.48 | 1.63 | .25 | .63 | 2.06 | .38 | 2.87 | 3.44 | 4.25 | 6.00 |
| | 1 | 1.499 | .50 | 2.50 | .38 | 2.23 | 1.48 | 1.63 | .50 | 1.00 | 2.44 | .38 | 2.87 | 3.44 | 4.25 | 6.38 |
| 2 | 1 | 1.499 | .50 | 3.00 | .63 | 2.36 | 1.48 | 2.05 | .25 | .75 | 2.39 | .50 | 2.91 | 4.13 | 5.13 | 6.50 |
| | 1.375 | 1.999 | .63 | 3.00 | .63 | 2.36 | 1.48 | 2.05 | .38 | 1.00 | 2.64 | .50 | 2.91 | 4.13 | 5.13 | 6.75 |
| 2 1/2 | 1 | 1.499 | .50 | 3.50 | .63 | 2.36 | 1.48 | 2.55 | .25 | .75 | 2.30 | .50 | 3.15 | 4.63 | 5.63 | 6.63 |
| | 1.375 | 1.999 | .63 | | | | | | 2.55 | 2.64 | 6.88 | | | | | |
| | 1.75 | 2.374 | .75 | | | | | | 2.80 | 2.80 | 7.13 | | | | | |
| 3 1/4 | 1.375 | 1.999 | .63 | 4.50 | .75 | 2.73 | 1.73 | 3.25 | .25 | .88 | 2.66 | .63 | 3.66 | 5.88 | 7.13 | 7.75 |
| | 1.75 | 2.374 | .75 | | | | | | 2.91 | 2.91 | 8.00 | | | | | |
| | 2 | 2.624 | .88 | | | | | | 3.03 | 3.03 | 8.13 | | | | | |
| 4 | 1.75 | 2.374 | .75 | 5.00 | .88 | 2.86 | 1.73 | 3.82 | .25 | 1.00 | 2.85 | .63 | 3.98 | 6.38 | 7.63 | 8.25 |
| | 2 | 2.624 | .88 | | | | | | 2.98 | 2.98 | 8.38 | | | | | |
| | 2.5 | 3.124 | 1.00 | | | | | | 3.23 | 3.23 | 8.63 | | | | | |
| 5 | 2 | 2.624 | .88 | 6.50 | .88 | 2.98 | 1.73 | 4.95 | .25 | 1.13 | 3.14 | .88 | 4.61 | 8.19 | 9.75 | 9.00 |
| | 2.5 | 3.124 | 1.00 | | | | | | 3.39 | 3.39 | 9.25 | | | | | |
| | 3 | 3.749 | 1.00 | | | | | | 3.39 | 3.39 | 9.25 | | | | | |
| | 3.5 | 4.249 | 1.00 | | | | | | 3.39 | 3.39 | 9.25 | | | | | |
| 6 | 2.5 | 3.124 | 1.00 | 7.50 | 1.00 | 3.23 | 2.23 | 5.73 | .25 | 1.25 | 3.50 | 1.00 | 4.88 | 9.44 | 11.25 | 10.63 |
| | 3 | 3.749 | | | | | | | 3.50 | 3.50 | 11.25 | | | | | |
| | 3.5 | 4.249 | | | | | | | 3.50 | 3.50 | 11.25 | | | | | |
| | 4 | 4.749 | | | | | | | 3.50 | 3.50 | 11.25 | | | | | |
| 7 | 3 | 3.749 | 1.00 | 8.50 | 1.00 | 3.73 | 2.73 | 6.58 | .25 | 1.25 | 3.81 | 1.13 | 5.38 | 10.63 | 12.63 | 11.88 |
| | 3.5 | 4.249 | | | | | | | 3.81 | 3.81 | 11.88 | | | | | |
| | 4 | 4.749 | | | | | | | 3.81 | 3.81 | 11.88 | | | | | |
| | 4.5 | 5.249 | | | | | | | 3.81 | 3.81 | 11.88 | | | | | |
| 8 | 3.5 | 4.249 | 1.00 | 9.63 | 1.00 | 4.23 | 2.98 | 7.50 | .25 | 1.25 | 3.86 | 1.25 | 6.50 | 11.81 | 14.00 | 13.00 |
| | 4 | 4.749 | | | | | | | 3.86 | 3.86 | 13.00 | | | | | |
| | 4.5 | 5.249 | | | | | | | 3.86 | 3.86 | 13.00 | | | | | |
| | 5 | 5.749 | | | | | | | 3.86 | 3.86 | 13.00 | | | | | |

TZ09 Head Rectangular Mounts (ANSI ME5)

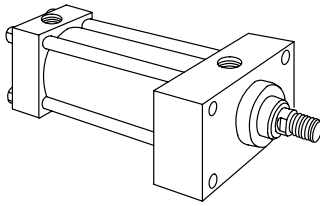

These mounts are ideal for straight line force transfer applications in which the cylinder is used in tension (pulling).

The mounting surface should be flat, and the rod end cartridge should be piloted into it.

The frame on which the cylinder is mounted must be sufficiently rigid to resist bending moments.

NOTE

For strokes in excess of 30 inches, see "Stop tube selection" on page NO TAG.

The force of the load should be perpendicular to the mounting surface

and parallel to the centerline of the piston rod. For eccentric loads, the larger of the two available rods in each bore size is recommended. Stop tubes should also be considered.

The head rectangular mounts (TZ09) is recommended for heavy duty applications.

Use high tensile socket head cap screws or hex head bolts tightened to the manufacturer's recommended torque.

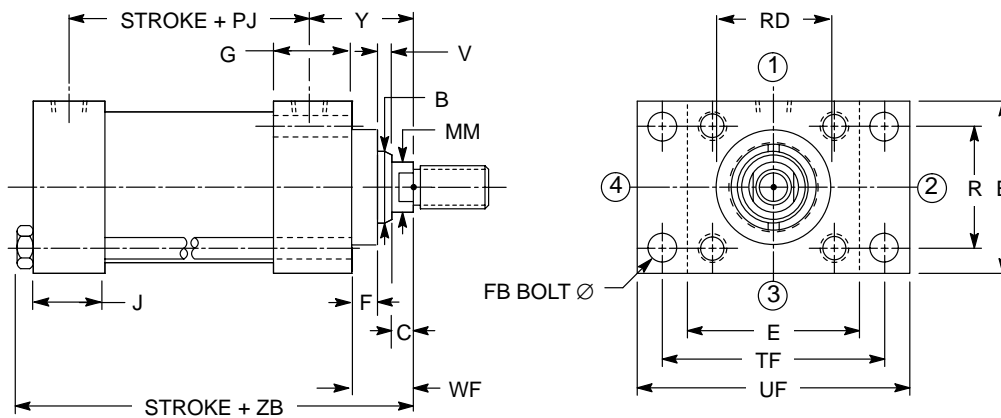

| Bore | Rod MM | ^{-0001-.002} B | C | E | Max. F | G | J | R | V | Y | FB | PJ+ | ^{+/-001} Max. RD | TF | UF | WF | Max ZB+ |
|-------|--------|-------------------------|------|------|--------|------|------|------|-----|------|------|------|---------------------------|-------|-------|------|---------|
| 1 1/2 | .625 | 1.124 | .38 | 2.50 | .38 | 1.75 | 1.48 | 1.63 | .25 | 2.06 | .38 | 2.87 | 2.439 | 3.44 | 4.25 | 1.00 | 6.00 |
| | 1 | 1.499 | .50 | 2.50 | .38 | 1.75 | 1.48 | 1.63 | .50 | 2.44 | .38 | 2.87 | 2.439 | 3.44 | 4.25 | 1.38 | 6.38 |
| 2 | 1 | 1.499 | .50 | 3.00 | .63 | 1.75 | 1.48 | 2.05 | .25 | 2.39 | .50 | 2.91 | 2.911 | 4.13 | 5.13 | 1.38 | 6.50 |
| | 1.375 | 1.999 | .63 | 3.00 | .63 | 1.75 | 1.48 | 2.05 | .38 | 2.64 | .50 | 2.91 | 2.911 | 4.13 | 5.13 | 1.63 | 6.75 |
| 2 1/2 | 1 | 1.499 | .50 | 3.50 | .63 | 1.75 | 1.48 | 2.55 | .25 | 2.30 | .50 | 3.15 | 2.951 | 4.63 | 5.63 | 1.38 | 6.63 |
| | 1.375 | 1.999 | .63 | 3.50 | .63 | 1.75 | 1.48 | 2.55 | .38 | 2.55 | .50 | 3.15 | 3.226 | 4.63 | 5.63 | 1.63 | 6.88 |
| | 1.75 | 2.374 | .75 | 3.50 | .63 | 1.75 | 1.48 | 2.55 | .50 | 2.80 | .50 | 3.15 | 3.462 | 4.63 | 5.63 | 1.88 | 7.13 |
| 3 1/4 | 1.375 | 1.999 | .63 | 4.50 | .75 | 2.00 | 1.73 | 3.25 | .25 | 2.66 | .63 | 3.66 | 3.226 | 5.88 | 7.13 | 1.63 | 7.75 |
| | 1.75 | 2.374 | .75 | 4.50 | .75 | 2.00 | 1.73 | 3.25 | .38 | 2.91 | .63 | 3.66 | 3.620 | 5.88 | 7.13 | 1.88 | 8.00 |
| | 2 | 2.624 | .88 | 4.50 | .75 | 2.00 | 1.73 | 3.25 | .38 | 3.03 | .63 | 3.66 | 4.131 | 5.88 | 7.13 | 2.00 | 8.13 |
| 4 | 1.75 | 2.374 | .75 | 5.00 | .88 | 2.00 | 1.73 | 3.82 | .25 | 2.85 | .63 | 3.98 | 3.620 | 6.38 | 7.63 | 1.88 | 8.25 |
| | 2 | 2.624 | .88 | 5.00 | .88 | 2.00 | 1.73 | 3.82 | .25 | 2.98 | .63 | 3.98 | 4.131 | 6.38 | 7.63 | 2.00 | 8.38 |
| | 2.5 | 3.124 | 1.00 | 5.00 | .88 | 2.00 | 1.73 | 3.82 | .38 | 3.23 | .63 | 3.98 | 4.918 | 6.38 | 7.63 | 2.25 | 8.63 |
| 5 | 2 | 2.624 | .88 | 6.50 | .88 | 2.00 | 1.73 | 4.95 | .25 | 3.14 | .88 | 4.61 | 4.131 | 8.19 | 9.75 | 2.00 | 9.00 |
| | 2.5 | 3.124 | 1.00 | 6.50 | .88 | 2.00 | 1.73 | 4.95 | .38 | 3.39 | .88 | 4.61 | 4.918 | 8.19 | 9.75 | 2.25 | 9.25 |
| | 3 | 3.749 | 1.00 | 6.50 | .88 | 2.00 | 1.73 | 4.95 | .38 | 3.39 | .88 | 4.61 | 5.903 | 8.19 | 9.75 | 2.25 | 9.25 |
| | 3.5 | 4.249 | 1.00 | 6.50 | .88 | 2.00 | 1.73 | 4.95 | .38 | 3.39 | .88 | 4.61 | 5.903 | 8.19 | 9.75 | 2.25 | 9.25 |
| 6 | 2.5 | 3.124 | 1.00 | 7.50 | 1.00 | 2.25 | 2.23 | 5.73 | .25 | 3.50 | 1.00 | 4.88 | 4.918 | 9.44 | 11.25 | 2.25 | 10.63 |
| | 3 | 3.749 | 1.00 | 7.50 | 1.00 | 2.25 | 2.23 | 5.73 | .25 | 3.50 | 1.00 | 4.88 | 5.903 | 9.44 | 11.25 | 2.25 | 10.63 |
| | 3.5 | 4.249 | 1.00 | 7.50 | 1.00 | 2.25 | 2.23 | 5.73 | .25 | 3.50 | 1.00 | 4.88 | 5.903 | 9.44 | 11.25 | 2.25 | 10.63 |
| | 4 | 4.749 | 1.00 | 7.50 | 1.00 | 2.25 | 2.23 | 5.73 | .25 | 3.50 | 1.00 | 4.88 | 7.084 | 9.44 | 11.25 | 2.25 | 10.63 |
| 7 | 3 | 3.749 | 1.00 | 8.50 | 1.00 | 2.75 | 2.73 | 6.58 | .25 | 3.81 | 1.13 | 5.38 | 5.903 | 10.63 | 12.63 | 2.25 | 11.88 |
| | 3.5 | 4.249 | 1.00 | 8.50 | 1.00 | 2.75 | 2.73 | 6.58 | .25 | 3.81 | 1.13 | 5.38 | 5.903 | 10.63 | 12.63 | 2.25 | 11.88 |
| | 4 | 4.749 | 1.00 | 8.50 | 1.00 | 2.75 | 2.73 | 6.58 | .25 | 3.81 | 1.13 | 5.38 | 6.690 | 10.63 | 12.63 | 2.25 | 11.88 |
| | 4.5 | 5.249 | 1.00 | 8.50 | 1.00 | 2.75 | 2.73 | 6.58 | .25 | 3.81 | 1.13 | 5.38 | 8.264 | 10.63 | 12.63 | 2.25 | 11.88 |
| | 5 | 5.749 | 1.00 | 8.50 | 1.00 | 2.75 | 2.73 | 6.58 | .25 | 3.81 | 1.13 | 5.38 | 8.264 | 10.63 | 12.63 | 2.25 | 11.88 |
| 8 | 3.5 | 4.249 | 1.00 | 9.63 | 1.00 | 3.25 | 2.98 | 7.50 | .25 | 3.86 | 1.25 | 6.50 | 5.903 | 11.81 | 14.00 | 2.25 | 13.00 |
| | 4 | 4.749 | 1.00 | 9.63 | 1.00 | 3.25 | 2.98 | 7.50 | .25 | 3.86 | 1.25 | 6.50 | 6.690 | 11.81 | 14.00 | 2.25 | 13.00 |
| | 4.5 | 5.249 | 1.00 | 9.63 | 1.00 | 3.25 | 2.98 | 7.50 | .25 | 3.86 | 1.25 | 6.50 | 6.690 | 11.81 | 14.00 | 2.25 | 13.00 |
| | 5 | 5.749 | 1.00 | 9.63 | 1.00 | 3.25 | 2.98 | 7.50 | .25 | 3.86 | 1.25 | 6.50 | 8.264 | 11.81 | 14.00 | 2.25 | 13.00 |
| | 5.5 | 6.249 | 1.00 | 9.63 | 1.00 | 3.25 | 2.98 | 7.50 | .25 | 3.86 | 1.25 | 6.50 | 8.264 | 11.81 | 14.00 | 2.25 | 13.00 |

+ Plus stroke

TZ10 Clevis Mount (ANSI MP1)

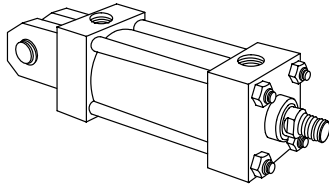

These mounts are for applications in which the machine member travels in a curved path within one plane.

These mounts can be used both in compression (push) and tension (pull). Care must be exercised to prevent rod buckling in compression applications with long strokes. See page 37 for stroke limitations.

NOTE

For strokes in excess of 24 inches, see "Stop tube selection" on page NO TAG.

The centerline of the machine member that attaches to the swivel pin must be perpendicular to the centerline of the piston rod and the curved path must be in one plane only. Any misalignment will cause excess side loading on the bearing and piston. This will lead to premature failure. For applications with small amounts of misalignment, consider the spherical bearing mount, as shown in the TV Catalog under TV11.

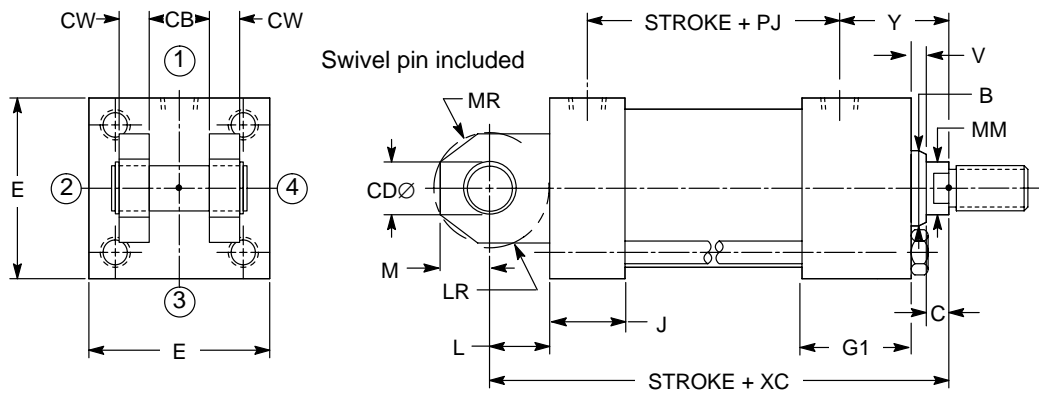

| Bore | Rod MM | ^{-0.000/-0.002} B | C | E | G1 | J | L | M | V | Y | CB | CD | Max. CW | LR | PJ+ | MR | XC+ |
|------|-----------|-------------------------------|------|------|------|------|------|------|-----|------|------|------|------------|------|------|------|-------|
| 1½ | .625 | 1.124 | .38 | 2.50 | 2.23 | 1.48 | .75 | .50 | .25 | 2.06 | .75 | .50 | .50 | .63 | 2.87 | .63 | 6.38 |
| | 1 | 1.499 | .50 | 2.50 | 2.23 | 1.48 | .75 | .50 | .50 | 2.44 | .75 | .50 | .50 | .63 | 2.87 | .63 | 6.75 |
| 2 | 1 | 1.499 | .50 | 3.00 | 2.36 | 1.48 | 1.25 | .75 | .25 | 2.39 | 1.25 | .75 | .63 | 1.13 | 2.91 | .88 | 7.25 |
| | 1.375 | 1.999 | .63 | 3.00 | 2.36 | 1.48 | 1.25 | .75 | .38 | 2.64 | 1.25 | .75 | .63 | 1.13 | 2.91 | .88 | 7.50 |
| 2½ | 1 | 1.499 | .50 | 3.50 | 2.36 | 1.48 | 1.25 | .75 | .25 | 2.30 | 1.25 | .75 | .63 | 1.13 | 3.15 | .88 | 7.38 |
| | 1.375 | 1.999 | .63 | 3.50 | 2.36 | 1.48 | 1.25 | .75 | .38 | 2.55 | 1.25 | .75 | .63 | 1.13 | 3.15 | .88 | 7.63 |
| 3¼ | 1.375 | 1.999 | .63 | 4.50 | 2.73 | 1.73 | 1.50 | 1.00 | .25 | 2.66 | 1.50 | 1.00 | .75 | 1.38 | 3.66 | 1.25 | 8.63 |
| | 1.75 | 2.374 | .75 | 4.50 | 2.73 | 1.73 | 1.50 | 1.00 | .38 | 2.91 | 1.50 | 1.00 | .75 | 1.38 | 3.66 | 1.25 | 8.88 |
| 4 | 2 | 2.624 | .88 | 5.00 | 2.86 | 1.73 | 2.13 | 1.38 | .25 | 2.85 | 2.00 | 1.38 | 1.00 | 1.88 | 3.98 | 1.63 | 9.75 |
| | 2.5 | 3.124 | 1.00 | 5.00 | 2.86 | 1.73 | 2.13 | 1.38 | .38 | 3.23 | 2.00 | 1.38 | 1.00 | 1.88 | 3.98 | 1.63 | 10.13 |
| 5 | 2 | 2.624 | .88 | 6.50 | 2.98 | 1.73 | 2.25 | 1.50 | .25 | 3.14 | 2.50 | 1.75 | 1.25 | 2.00 | 4.61 | 1.88 | 10.50 |
| | 2.5 | 3.124 | 1.00 | 6.50 | 2.98 | 1.73 | 2.25 | 1.50 | .38 | 3.39 | 2.50 | 1.75 | 1.25 | 2.00 | 4.61 | 1.88 | 10.75 |
| | 3 | 3.749 | 1.00 | 6.50 | 2.98 | 1.73 | 2.25 | 1.50 | .38 | 3.39 | 2.50 | 1.75 | 1.25 | 2.00 | 4.61 | 1.88 | 10.75 |
| | 3.5 | 4.249 | 1.00 | 6.50 | 2.98 | 1.73 | 2.25 | 1.50 | .38 | 3.36 | 2.50 | 1.75 | 1.25 | 2.00 | 4.61 | 1.88 | 10.75 |
| 6 | 2.5 | 3.124 | 1.00 | 7.50 | 3.23 | 2.23 | 2.50 | 2.00 | .25 | 3.50 | 2.50 | 2.00 | 1.25 | 2.25 | 4.88 | 2.09 | 12.13 |
| | 3 | 3.749 | 1.00 | 7.50 | 3.23 | 2.23 | 2.50 | 2.00 | .25 | 3.50 | 2.50 | 2.00 | 1.25 | 2.25 | 4.88 | 2.09 | 12.13 |
| | 3.5 | 4.249 | 1.00 | 7.50 | 3.23 | 2.23 | 2.50 | 2.00 | .25 | 3.50 | 2.50 | 2.00 | 1.25 | 2.25 | 4.88 | 2.09 | 12.13 |
| | 4 | 4.749 | 1.00 | 7.50 | 3.23 | 2.23 | 2.50 | 2.00 | .25 | 3.50 | 2.50 | 2.00 | 1.25 | 2.25 | 4.88 | 2.09 | 12.13 |
| 7 | 3 | 3.749 | 1.00 | 8.50 | 3.73 | 2.73 | 3.00 | 2.50 | .25 | 3.81 | 3.00 | 2.50 | 1.50 | 2.75 | 5.38 | 2.63 | 13.75 |
| | 3.5 | 4.249 | 1.00 | 8.50 | 3.73 | 2.73 | 3.00 | 2.50 | .25 | 3.81 | 3.00 | 2.50 | 1.50 | 2.75 | 5.38 | 2.63 | 13.75 |
| | 4 | 4.749 | 1.00 | 8.50 | 3.73 | 2.73 | 3.00 | 2.50 | .25 | 3.81 | 3.00 | 2.50 | 1.50 | 2.75 | 5.38 | 2.63 | 13.75 |
| | 4.5 | 5.249 | 1.00 | 8.50 | 3.73 | 2.73 | 3.00 | 2.50 | .25 | 3.81 | 3.00 | 2.50 | 1.50 | 2.75 | 5.38 | 2.63 | 13.75 |
| 8 | 3.5 | 4.249 | 1.00 | 9.63 | 4.23 | 2.98 | 3.25 | 2.75 | .25 | 3.86 | 3.00 | 3.00 | 1.50 | 3.00 | 6.50 | 2.88 | 15.00 |
| | 4 | 4.749 | 1.00 | 9.63 | 4.23 | 2.98 | 3.25 | 2.75 | .25 | 3.86 | 3.00 | 3.00 | 1.50 | 3.00 | 6.50 | 2.88 | 15.00 |
| | 4.5 | 5.249 | 1.00 | 9.63 | 4.23 | 2.98 | 3.25 | 2.75 | .25 | 3.86 | 3.00 | 3.00 | 1.50 | 3.00 | 6.50 | 2.88 | 15.00 |
| | 5 | 5.749 | 1.00 | 9.63 | 4.23 | 2.98 | 3.25 | 2.75 | .25 | 3.86 | 3.00 | 3.00 | 1.50 | 3.00 | 6.50 | 2.88 | 15.00 |

+ Plus stroke

TZ12 Cap Rectangular Flange (ANSI MF2)

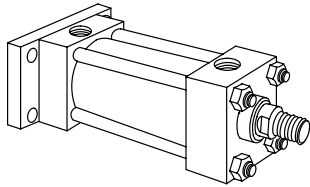

These mounts are ideal for straight line force transfer applications in which the

cylinder is used in compression (pushing), as in push presses.

For tension applications (pulling), a head rectangular mount is more appropriate.

NOTE

For strokes in excess of 30 inches, see "Stop tube selection" on page NO TAG.

The frame on which the cylinder is mounted must be sufficiently rigid to resist bending moments.

The cap rectangular mounts (TZ14) is recommended for heavy duty applications. TZ12 mounts are only rated for a maximum of 800 psi (55 bar) on the pull stroke.

Use high tensile socket head cap screws or hex head bolts tightened to the manufacturer's recommended torque.

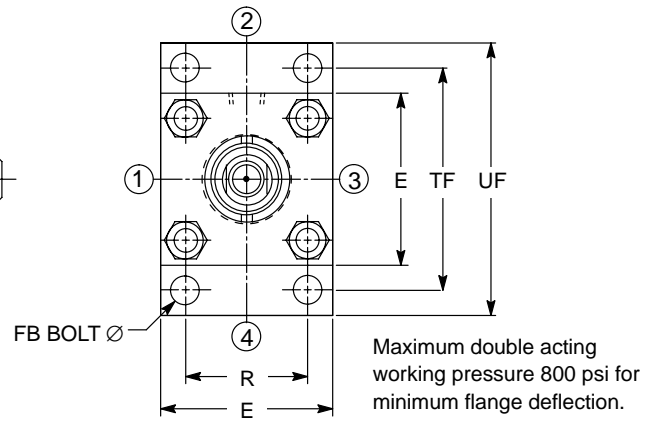
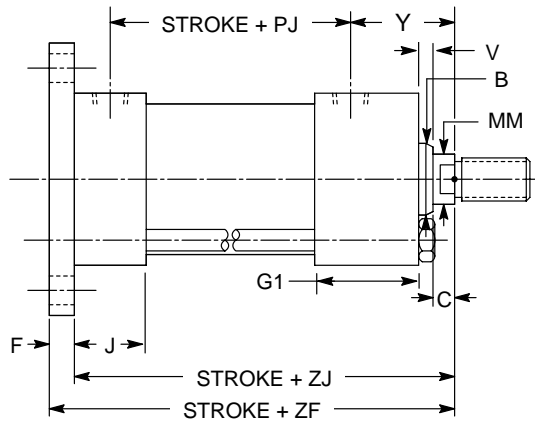

Maximum double acting working pressure 800 psi for minimum flange deflection.

| Bore | Rod MM | ^{-0.0001-.002} B | C | E | F | G1 | J | R | V | Y | FB | PJ+ | TF | UF | ZF+ | ZJ+ | | |
|-------|--------|---------------------------|------|------|------|------|------|------|-----|------|------|------|-------|-------|-------|-------|------|------|
| 1 1/2 | .625 | 1.124 | .38 | 2.50 | .38 | 2.23 | 1.48 | 1.63 | .25 | 2.06 | .38 | 2.87 | 3.44 | 4.25 | 6.00 | 5.63 | | |
| | 1 | 1.499 | .50 | 2.50 | .38 | 2.23 | 1.48 | 1.63 | .50 | 2.44 | .38 | 2.87 | 3.44 | 4.25 | 6.38 | 6.00 | | |
| 2 | 1 | 1.499 | .50 | 3.00 | .63 | 2.36 | 1.48 | 2.05 | .25 | 2.39 | .50 | 2.91 | 4.13 | 5.13 | 6.63 | 6.00 | | |
| | 1.375 | 1.999 | .63 | 3.00 | .63 | 2.36 | 1.48 | 2.05 | .38 | 2.64 | .50 | 2.91 | 4.13 | 5.13 | 6.88 | 6.25 | | |
| 2 1/2 | 1 | 1.499 | .50 | 3.50 | .63 | 2.36 | 1.48 | 2.55 | .25 | 2.30 | .50 | 3.15 | 4.63 | 5.63 | 6.75 | 6.13 | | |
| | 1.375 | 1.999 | .63 | | | | | | .38 | 2.55 | | | | | | | 7.00 | 6.38 |
| | 1.75 | 2.374 | .75 | | | | | | .50 | 2.80 | | | | | | | 7.25 | 6.63 |
| 3 1/4 | 1.375 | 1.999 | .63 | 4.50 | .75 | 2.73 | 1.73 | 3.25 | .25 | 2.66 | .63 | 3.66 | 5.88 | 7.13 | 7.88 | 7.13 | | |
| | 1.75 | 2.374 | .75 | | | | | | .38 | 2.91 | | | | | | | 8.13 | 7.38 |
| | 2 | 2.624 | .88 | | | | | | .38 | 3.03 | | | | | | | 8.25 | 7.50 |
| 4 | 1.75 | 2.374 | .75 | 5.00 | .88 | 2.86 | 1.73 | 3.82 | .25 | 2.85 | .63 | 3.98 | 6.38 | 7.63 | 8.50 | 7.63 | | |
| | 2 | 2.624 | .88 | | | | | | .25 | 2.98 | | | | | | | 8.63 | 7.75 |
| | 2.5 | 3.124 | 1.00 | | | | | | .38 | 3.23 | | | | | | | 8.88 | 8.00 |
| 5 | 2 | 2.624 | .88 | 6.50 | .88 | 2.98 | 1.73 | 4.95 | .25 | 3.14 | .88 | 4.61 | 8.19 | 9.75 | 9.13 | 8.25 | | |
| | 2.5 | 3.124 | 1.00 | | | | | | .38 | 3.39 | | | | | | | 9.38 | 8.50 |
| | 3 | 3.749 | 1.00 | | | | | | .38 | 3.39 | | | | | | | 9.38 | 8.50 |
| | 3.5 | 4.249 | 1.00 | | | | | | .38 | 3.39 | | | | | | | 9.38 | 8.50 |
| 6 | 2.5 | 3.124 | 1.00 | 7.50 | 1.00 | 3.23 | 2.23 | 5.73 | .25 | 3.50 | 1.00 | 4.88 | 9.44 | 11.25 | 10.63 | 9.63 | | |
| | 3 | 3.749 | | | | | | | | | | | | | | | | |
| | 3.5 | 4.249 | | | | | | | | | | | | | | | | |
| | 4 | 4.749 | | | | | | | | | | | | | | | | |
| 7 | 3 | 3.749 | 1.00 | 8.50 | 1.00 | 3.73 | 2.73 | 6.58 | .25 | 3.81 | 1.13 | 5.38 | 10.63 | 12.63 | 11.75 | 10.75 | | |
| | 3.5 | 4.249 | | | | | | | | | | | | | | | | |
| | 4 | 4.749 | | | | | | | | | | | | | | | | |
| | 4.5 | 5.249 | | | | | | | | | | | | | | | | |
| 8 | 3.5 | 4.249 | 1.00 | 9.63 | 1.00 | 4.23 | 2.98 | 7.50 | .25 | 3.86 | 1.25 | 6.50 | 11.81 | 14.00 | 12.75 | 11.75 | | |
| | 4 | 4.749 | | | | | | | | | | | | | | | | |
| | 4.5 | 5.249 | | | | | | | | | | | | | | | | |
| | 5 | 5.749 | | | | | | | | | | | | | | | | |
| | 5.5 | 6.249 | | | | | | | | | | | | | | | | |

+ Plus stroke

TZ13 Cap Square Flange (ANSI MF6)

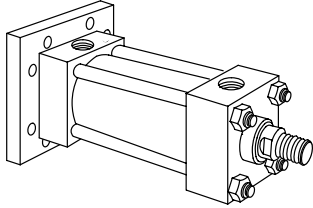

These mounts are ideal for straight line force transfer applications in which the

cylinder is used in compression (pushing), as in push presses.

For tension applications (pulling), a head rectangular mount is more appropriate.

NOTE

For strokes in excess of 30 inches, see "Stop tube selection" on page NO TAG.

The frame on which the cylinder is mounted must be sufficiently rigid to resist bending moments.

The cap rectangular mounts (TZ14) is recommended for heavy duty applications. Seven and eight inch bore TZ13 mounts are only rated for a maximum of 1500 psi (105 bar) pull stroke.

Use high tensile socket head cap screws or hex head bolts tightened to the manufacturer's recommended torque.

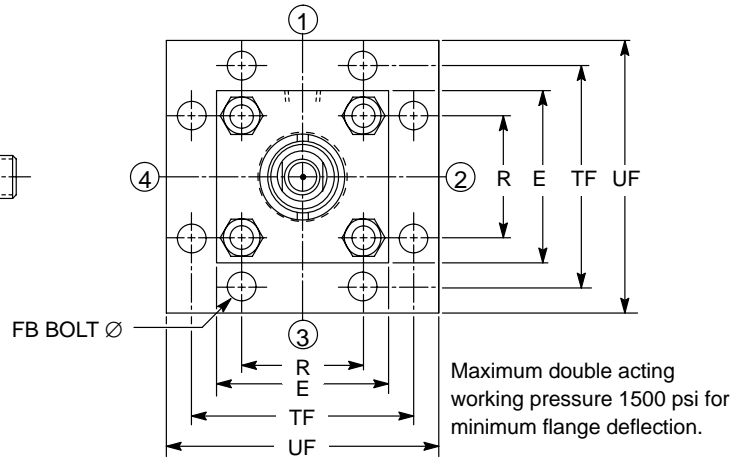
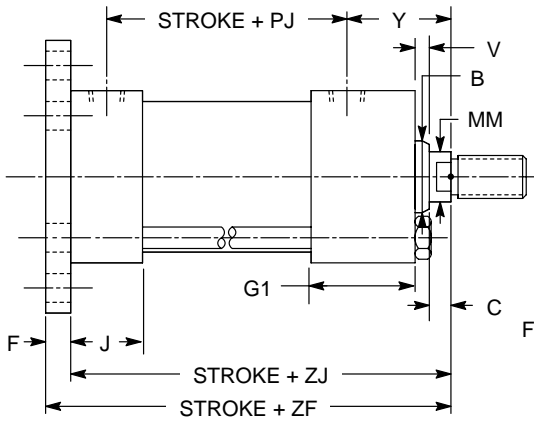

| Bore | Rod MM | ^{-0.001/-0.002} B | C | E | F | G1 | J | R | V | Y | FB | PJ+ | TF | UF | ZF+ | ZJ+ |
|------|--------|----------------------------|------|------|------|------|------|------|-----|------|------|------|-------|-------|-------|-------|
| 1½ | .625 | 1.124 | .38 | 2.50 | .38 | 2.23 | 1.48 | 1.63 | .25 | 2.06 | .38 | 2.87 | 3.44 | 4.25 | 6.00 | 5.63 |
| | 1 | 1.499 | .50 | 2.50 | .38 | 2.23 | 1.48 | 1.63 | .50 | 2.44 | .38 | 2.87 | 3.44 | 4.25 | 6.38 | 6.00 |
| 2 | 1 | 1.499 | .50 | 3.00 | .63 | 2.36 | 1.48 | 2.05 | .25 | 2.39 | .50 | 2.91 | 4.13 | 5.13 | 6.63 | 6.00 |
| | 1.375 | 1.999 | .63 | 3.00 | .63 | 2.36 | 1.48 | 2.05 | .38 | 2.64 | .50 | 2.91 | 4.13 | 5.13 | 6.88 | 6.25 |
| 2½ | 1 | 1.499 | .50 | 3.50 | .63 | 2.36 | 1.48 | 2.55 | .25 | 2.30 | .50 | 3.15 | 4.63 | 5.63 | 6.75 | 6.13 |
| | 1.375 | 1.999 | .63 | | | | | | .38 | 2.55 | | | | | 7.00 | 6.38 |
| | 1.75 | 2.374 | .75 | | | | | | .50 | 2.80 | | | | | 7.25 | 6.63 |
| 3¼ | 1.375 | 1.999 | .63 | 4.50 | .75 | 2.73 | 1.73 | 3.25 | .25 | 2.66 | .63 | 3.66 | 5.88 | 7.13 | 7.88 | 7.13 |
| | 1.75 | 2.374 | .75 | | | | | | .38 | 2.91 | | | | | 8.13 | 7.38 |
| | 2 | 2.624 | .88 | | | | | | .38 | 3.03 | | | | | 8.25 | 7.50 |
| 4 | 1.75 | 2.374 | .75 | 5.00 | .88 | 2.86 | 1.73 | 3.82 | .25 | 2.85 | .63 | 3.98 | 6.38 | 7.63 | 8.50 | 7.63 |
| | 2 | 2.624 | .88 | | | | | | .25 | 2.98 | | | | | 8.63 | 7.75 |
| | 2.5 | 3.124 | 1.00 | | | | | | .38 | 3.23 | | | | | 8.88 | 8.00 |
| 5 | 2 | 2.624 | .88 | 6.50 | .88 | 2.98 | 1.73 | 4.95 | .25 | 3.14 | .88 | 4.61 | 8.19 | 9.75 | 9.13 | 8.25 |
| | 2.5 | 3.124 | 1.00 | | | | | | .38 | 3.39 | | | | | 9.38 | 8.50 |
| | 3 | 3.749 | 1.00 | | | | | | .38 | 3.39 | | | | | 9.38 | 8.50 |
| | 3.5 | 4.249 | 1.00 | | | | | | .38 | 3.39 | | | | | 9.38 | 8.50 |
| 6 | 2.5 | 3.124 | 1.00 | 7.50 | 1.00 | 3.23 | 2.23 | 5.73 | .25 | 3.50 | 1.00 | 4.88 | 9.44 | 11.25 | 10.63 | 9.63 |
| | 3 | 3.749 | | | | | | | | | | | | | | |
| | 3.5 | 4.249 | | | | | | | | | | | | | | |
| | 4 | 4.749 | | | | | | | | | | | | | | |
| 7 | 3 | 3.749 | 1.00 | 8.50 | 1.00 | 3.73 | 2.73 | 6.58 | .25 | 3.81 | 1.13 | 5.38 | 10.63 | 12.63 | 11.75 | 10.75 |
| | 3.5 | 4.249 | | | | | | | | | | | | | | |
| | 4 | 4.749 | | | | | | | | | | | | | | |
| | 4.5 | 5.249 | | | | | | | | | | | | | | |
| | 5 | 5.749 | | | | | | | | | | | | | | |
| 8 | 3.5 | 4.249 | 1.00 | 9.63 | 1.00 | 4.23 | 2.98 | 7.50 | .25 | 3.86 | 1.25 | 6.50 | 11.81 | 14.00 | 12.75 | 11.75 |
| | 4 | 4.749 | | | | | | | | | | | | | | |
| | 4.5 | 5.249 | | | | | | | | | | | | | | |
| | 5 | 5.749 | | | | | | | | | | | | | | |
| | 5.5 | 6.249 | | | | | | | | | | | | | | |

+ Plus stroke

TZ14 Cap Rectangular Mounts (ANSI ME6)

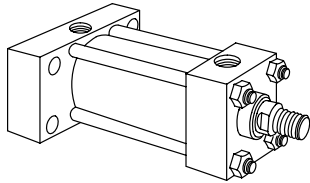

These mounts are for straight line force transfer applications in which the cylinder is used in compression (pushing) and tension (pulling) applications.

The mounting surface should be flat and perpendicular to the force of the load.

The frame on which the cylinder is mounted must be sufficiently rigid to resist bending moments.

The cap rectangular mount (TZ14) is recommended for heavy duty applications.

NOTE

For strokes in excess of 30 inches, see "Stop tube selection" on page NO TAG.

Use high tensile socket head cap screws or hex head bolts tightened to the manufacturer's recommended torque value.

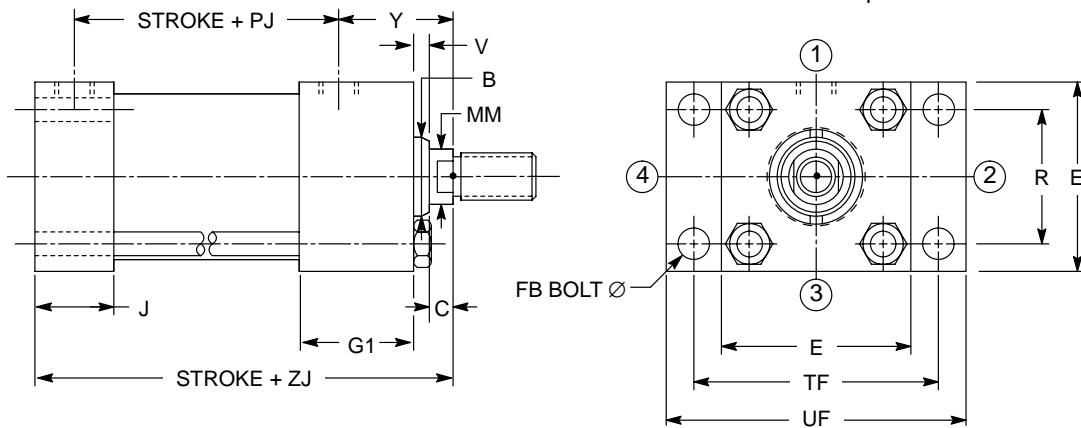

| Bore | Rod MM | ^{-000/-002} B | C | E | G1 | J | R | V | Y | FB | PJ+ | TF | UF | ZJ+ |
|------|--------|------------------------|------|------|------|------|------|-----|------|------|------|-------|-------|-------|
| 1½ | .625 | 1.124 | .38 | 2.50 | 2.23 | 1.50 | 1.63 | .25 | 2.06 | .38 | 2.87 | 3.44 | 4.25 | 5.63 |
| | 1 | 1.499 | .50 | 2.50 | 2.23 | 1.50 | 1.63 | .50 | 2.44 | .38 | 2.87 | 3.44 | 4.25 | 6.00 |
| 2 | 1 | 1.499 | .50 | 3.00 | 2.36 | 1.50 | 2.05 | .25 | 2.39 | .50 | 2.91 | 4.13 | 5.13 | 6.00 |
| | 1.375 | 1.999 | .63 | 3.00 | 2.36 | 1.50 | 2.05 | .38 | 2.64 | .50 | 2.91 | 4.13 | 5.13 | 6.25 |
| 2½ | 1 | 1.499 | .50 | 3.50 | 2.36 | 1.50 | 2.55 | .25 | 2.30 | .50 | 3.15 | 4.63 | 5.63 | 6.13 |
| | 1.375 | 1.999 | .63 | | | | | .38 | 2.55 | | | | | 6.38 |
| | 1.75 | 2.374 | .75 | | | | | .50 | 2.80 | | | | | 6.63 |
| 3¼ | 1.375 | 1.999 | .63 | 4.50 | 2.73 | 1.75 | 3.25 | .25 | 2.66 | .63 | 3.66 | 5.88 | 7.13 | 7.13 |
| | 1.75 | 2.374 | .75 | | | | | .38 | 2.91 | | | | | 7.38 |
| | 2 | 2.624 | .88 | | | | | .38 | 3.03 | | | | | 7.50 |
| 4 | 1.75 | 2.374 | .75 | 5.00 | 2.86 | 1.75 | 3.82 | .25 | 2.85 | .63 | 3.98 | 6.38 | 7.63 | 7.63 |
| | 2 | 2.624 | .88 | | | | | .25 | 2.98 | | | | | 7.75 |
| | 2.5 | 3.124 | 1.00 | | | | | .38 | 3.23 | | | | | 8.00 |
| 5 | 2 | 2.624 | .88 | 6.50 | 2.98 | 1.75 | 4.95 | .25 | 3.14 | .88 | 4.61 | 8.19 | 9.75 | 8.25 |
| | 2.5 | 3.124 | 1.00 | | | | | .38 | 3.39 | | | | | 8.50 |
| | 3 | 3.749 | 1.00 | | | | | .38 | 3.39 | | | | | 8.50 |
| | 3.5 | 4.249 | 1.00 | | | | | .38 | 3.39 | | | | | 8.50 |
| 6 | 2.5 | 3.124 | 1.00 | 7.50 | 3.23 | 2.25 | 5.73 | .25 | 3.50 | 1.00 | 4.88 | 9.44 | 11.25 | 9.63 |
| | 3 | 3.749 | | | | | | | | | | | | |
| | 3.5 | 4.249 | | | | | | | | | | | | |
| | 4 | 4.749 | | | | | | | | | | | | |
| 7 | 3 | 3.749 | 1.00 | 8.50 | 3.73 | 2.75 | 6.58 | .25 | 3.81 | 1.13 | 5.38 | 10.63 | 12.63 | 10.75 |
| | 3.5 | 4.249 | | | | | | | | | | | | |
| | 4 | 4.749 | | | | | | | | | | | | |
| | 4.5 | 5.249 | | | | | | | | | | | | |
| 8 | 3.5 | 4.249 | 1.00 | 9.63 | 4.23 | 3.00 | 7.50 | .25 | 3.86 | 1.25 | 6.50 | 11.81 | 14.00 | 11.75 |
| | 4 | 4.749 | | | | | | | | | | | | |
| | 4.5 | 5.249 | | | | | | | | | | | | |
| | 5 | 5.749 | | | | | | | | | | | | |
| | 5.5 | 6.249 | | | | | | | | | | | | |

+ Plus stroke

TZ15 Intermediate Trunnion Mount

(ANSI MT4)

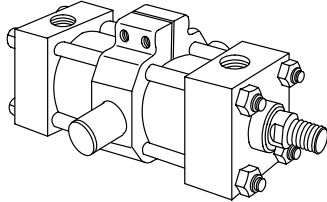

The Intermediate Trunnion Mount is for longer stroke applications in which the machine member travels in a curved path in one plane.

On special orders, the trunnion can be located anywhere along the body.

This mount can be used both in compression (push) and tension (pull) applications.

NOTE

For strokes in excess of 24 inches, see "Stop tube selection" on page NO TAG.

It is recommended that rigidly mounted pillow blocks with bearings at least as long as the trunnion pins be used. The pillow blocks should be installed as close to the shoulder of the trunnion as possible.

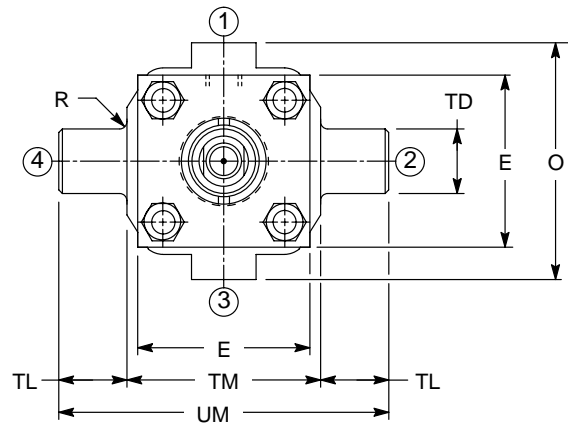
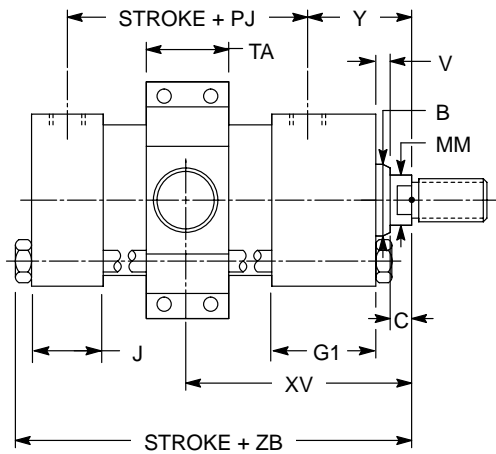

| Bore | Rod MM | ^{-0.001/-0.002} B | C | E | G1 | J | Max. O | V | Y | PJ+ | TA | ^{-0.001/-0.002} TD | TL | TM | UM | Min | XV* Std* | Max+ | Max ZB+ |
|-------|-----------|-------------------------------|-----|------|------|------|-----------|-----|------|------|------|--------------------------------|------|------|-------|------|-------------|------|------------|
| 1 1/2 | .625 | 1.124 | .38 | 2.50 | 2.23 | 1.48 | 3.38 | .25 | 2.06 | 2.87 | 1.14 | 1.000 | .63 | 3.00 | 4.26 | 3.49 | 3.44 | 3.53 | 6.00 |
| | 1 | 1.499 | .50 | 2.50 | 2.23 | 1.48 | 3.38 | .50 | 2.44 | 2.87 | 1.14 | 1.000 | .63 | 3.00 | 4.26 | 3.86 | 3.81 | 3.91 | 6.38 |
| 2 | 1 | 1.499 | .50 | 3.00 | 2.36 | 1.48 | 4.13 | .25 | 2.39 | 2.91 | 1.52 | 1.375 | .79 | 3.50 | 5.08 | 3.92 | 3.81 | 3.72 | 6.50 |
| | 1.375 | 1.999 | .63 | 3.00 | 2.36 | 1.48 | 4.13 | .38 | 2.64 | 2.91 | 1.52 | 1.375 | .79 | 3.50 | 5.08 | 4.17 | 4.19 | 3.97 | 6.75 |
| 2 1/2 | 1 | 1.499 | .50 | 3.50 | 2.36 | 1.48 | 4.80 | .25 | 2.30 | 3.15 | 1.67 | 1.375 | .98 | 4.00 | 5.96 | 4.00 | 3.88 | 3.47 | 6.63 |
| | 1.375 | 1.999 | .63 | 3.50 | 2.36 | 1.48 | 4.80 | .38 | 2.55 | 3.15 | 1.67 | 1.375 | .98 | 4.00 | 5.96 | 4.25 | 4.13 | 3.99 | 6.88 |
| 2 1/2 | 1.75 | 2.374 | .75 | 4.50 | 2.73 | 1.73 | 6.00 | .50 | 2.80 | 3.15 | 1.67 | 1.375 | .98 | 4.00 | 5.96 | 4.50 | 4.38 | 4.24 | 7.13 |
| | 2 | 2.624 | .88 | 4.50 | 2.73 | 1.73 | 6.00 | .38 | 3.03 | 3.15 | 1.67 | 1.375 | .98 | 4.00 | 5.96 | 4.25 | 4.13 | 3.99 | 6.88 |
| 3 1/4 | 1.375 | 1.999 | .63 | 4.50 | 2.73 | 1.73 | 6.00 | .25 | 2.66 | 3.66 | 2.01 | 1.750 | 1.26 | 5.00 | 7.52 | 4.67 | 4.50 | 4.34 | 7.75 |
| | 1.75 | 2.374 | .75 | 4.50 | 2.73 | 1.73 | 6.00 | .38 | 2.91 | 3.66 | 2.01 | 1.750 | 1.26 | 5.00 | 7.52 | 4.92 | 4.75 | 4.59 | 8.00 |
| 4 | 2 | 2.624 | .88 | 5.00 | 2.86 | 1.73 | 6.81 | .25 | 2.85 | 3.98 | 2.60 | 1.750 | 1.57 | 5.50 | 8.64 | 5.21 | 4.88 | 4.53 | 8.25 |
| | 2.5 | 3.124 | 1.0 | 5.00 | 2.86 | 1.73 | 6.81 | .38 | 3.23 | 3.98 | 2.60 | 1.750 | 1.57 | 5.50 | 8.64 | 5.34 | 5.00 | 4.66 | 8.38 |
| 5 | 2 | 2.624 | .88 | 5.00 | 2.86 | 1.73 | 6.81 | .25 | 3.14 | 4.61 | 3.31 | 1.750 | 1.75 | 7.00 | 10.5 | 5.82 | 5.25 | 4.81 | 9.00 |
| | 2.5 | 3.124 | 1.0 | 5.00 | 2.86 | 1.73 | 6.81 | .38 | 3.39 | 4.61 | 3.31 | 1.750 | 1.75 | 7.00 | 10.5 | 6.07 | 5.50 | 5.06 | 9.25 |
| 5 | 3 | 3.749 | 1.0 | 6.50 | 2.98 | 1.73 | 8.43 | .38 | 3.39 | 4.61 | 3.31 | 1.750 | 1.75 | 7.00 | 10.5 | 6.07 | 5.50 | 5.06 | 9.25 |
| | 3.5 | 4.249 | 1.0 | 6.50 | 2.98 | 1.73 | 8.43 | .38 | 3.39 | 4.61 | 3.31 | 1.750 | 1.75 | 7.00 | 10.5 | 6.07 | 5.50 | 5.06 | 9.25 |
| 6 | 2.5 | 3.124 | 1.0 | 7.50 | 3.23 | 2.23 | 10.23 | .25 | 3.50 | 4.88 | 3.90 | 2.000 | 1.97 | 8.50 | 12.4 | 6.49 | 5.94 | 5.39 | 10.63 |
| | 3 | 3.749 | 1.0 | 7.50 | 3.23 | 2.23 | 10.23 | .25 | 3.50 | 4.88 | 3.90 | 2.000 | 1.97 | 8.50 | 12.4 | 6.49 | 5.94 | 5.39 | 10.63 |
| 7 | 3.5 | 4.249 | 1.0 | 8.50 | 3.73 | 2.73 | 11.50 | .25 | 3.81 | 5.38 | 4.65 | 2.500 | 2.50 | 9.75 | 14.75 | 7.36 | 6.50 | 5.64 | 11.88 |
| | 4 | 4.749 | 1.0 | 8.50 | 3.73 | 2.73 | 11.50 | .25 | 3.81 | 5.38 | 4.65 | 2.500 | 2.50 | 9.75 | 14.75 | 7.36 | 6.50 | 5.64 | 11.88 |
| 8 | 4.5 | 5.249 | 1.0 | 9.63 | 4.23 | 2.98 | 13.66 | .25 | 3.86 | 6.50 | 5.24 | 3.000 | 3.00 | 11.0 | 17.0 | 8.16 | 7.13 | 6.10 | 13.00 |
| | 5 | 5.749 | 1.0 | 9.63 | 4.23 | 2.98 | 13.66 | .25 | 3.86 | 6.50 | 5.24 | 3.000 | 3.00 | 11.0 | 17.0 | 8.16 | 7.13 | 6.10 | 13.00 |
| 8 | 5.5 | 6.249 | 1.0 | 9.63 | 4.23 | 2.98 | 13.66 | .25 | 3.86 | 6.50 | 5.24 | 3.000 | 3.00 | 11.0 | 17.0 | 8.16 | 7.13 | 6.10 | 13.00 |
| | 5.5 | 6.249 | 1.0 | 9.63 | 4.23 | 2.98 | 13.66 | .25 | 3.86 | 6.50 | 5.24 | 3.000 | 3.00 | 11.0 | 17.0 | 8.16 | 7.13 | 6.10 | 13.00 |

* The standard XV dimension is Stroke/2 + XV (std.) unless otherwise specified.
+ Plus stroke

TZ16 Cap Trunnion Mounts (ANSI MT2)

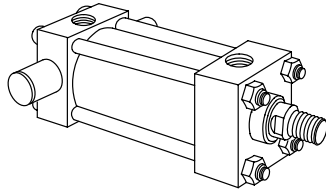

Either mount can be used both in compression (push) and tension (pull) applications. When used in compression applications, head trunnion mounts provide a longer maximum stroke than cap trunnion mounts.

NOTE

For strokes in excess of 24 inches, see "Stop tube selection" on page NO TAG.

an extremely tight fit to the mating machine member and permit curvilinear motion.

It is recommended that rigidly mounted pillow blocks with bearings at least as long as the trunnion pins be used. The pillow blocks should be installed as close to the shoulder of the trunnion as possible.

These mounts are for applications in which the machine member travels in a curved path in one plane.

The trunnion pins are an integral part of the head and can be sleeved to provide

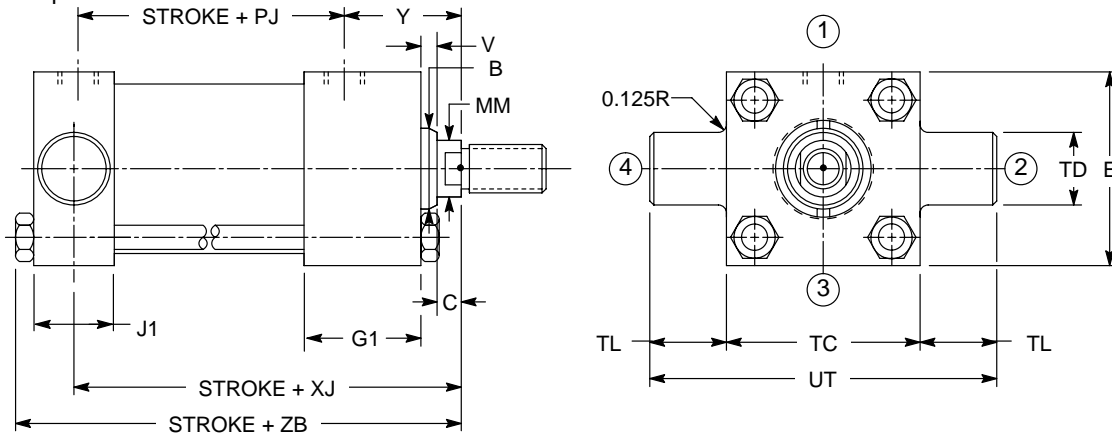

| Bore | Rod MM | ^{-000/-002} B | C | E | G1 | J1 | V | Y | PJ+ | TC | ^{-000/-002} TD | TL | UT | XJ+ | Max ZB+ |
|-------|-----------|---------------------------|------|------|------|------|-----|------|------|------|----------------------------|------|------|-------|------------|
| 1 1/2 | .625 | 1.24 | .38 | 2.50 | 2.23 | 1.48 | .25 | 2.06 | 2.87 | 2.50 | 1.000 | 1.00 | 4.50 | 4.88 | 6.00 |
| | 1 | 1.499 | .50 | 2.50 | 2.23 | 1.48 | .50 | 2.44 | 2.87 | 2.50 | 1.000 | 1.00 | 4.50 | 5.25 | 6.38 |
| 2 | 1 | 1.499 | .50 | 3.00 | 2.36 | 1.48 | .25 | 2.39 | 2.91 | 3.00 | 1.375 | 1.38 | 5.75 | 5.25 | 6.50 |
| | 1.375 | 1.999 | .63 | 3.00 | 2.36 | 1.48 | .38 | 2.64 | 2.91 | 3.00 | 1.375 | 1.38 | 5.75 | 5.50 | 6.75 |
| 2 1/2 | 1 | 1.499 | .50 | 3.50 | 2.36 | 1.48 | .25 | 2.30 | 3.15 | 3.50 | 1.375 | 1.38 | 6.25 | 5.38 | 6.63 |
| | 1.375 | 1.999 | .63 | 3.50 | 2.36 | 1.48 | .38 | 2.55 | 3.15 | 3.50 | 1.375 | 1.38 | 6.25 | 5.63 | 6.88 |
| 3 1/4 | 1.375 | 1.999 | .63 | 4.50 | 2.73 | 1.98 | .25 | 2.66 | 3.66 | 4.50 | 1.750 | 1.75 | 8.00 | 6.25 | 7.75 |
| | 1.75 | 2.374 | .75 | 4.50 | 2.73 | 1.98 | .38 | 2.91 | 3.66 | 4.50 | 1.750 | 1.75 | 8.00 | 6.50 | 8.13 |
| 4 | 2 | 2.624 | .88 | 5.00 | 2.86 | 1.98 | .25 | 2.85 | 3.98 | 5.00 | 1.750 | 1.75 | 8.50 | 6.75 | 8.40 |
| | 2.5 | 3.124 | 1.00 | 5.00 | 2.86 | 1.98 | .38 | 2.98 | 3.98 | 5.00 | 1.750 | 1.75 | 8.50 | 6.88 | 8.50 |
| 5 | 3 | 3.749 | 1.00 | 6.50 | 2.98 | 1.98 | .25 | 3.14 | 4.61 | 6.50 | 1.750 | 1.75 | 10.0 | 7.38 | 9.25 |
| | 3.5 | 4.249 | 1.00 | 6.50 | 2.98 | 1.98 | .38 | 3.39 | 4.61 | 6.50 | 1.750 | 1.75 | 10.0 | 7.63 | 9.44 |
| 6 | 4 | 4.749 | 1.00 | 7.50 | 3.23 | 2.23 | .25 | 3.50 | 4.88 | 7.50 | 2.000 | 2.00 | 11.5 | 8.38 | 10.63 |
| | 4.5 | 5.249 | 1.00 | 7.50 | 3.23 | 2.23 | .38 | 3.39 | 4.88 | 7.50 | 2.000 | 2.00 | 11.5 | 8.38 | 10.63 |
| 7 | 5 | 5.749 | 1.00 | 8.50 | 3.73 | 2.73 | .25 | 3.81 | 5.38 | 8.50 | 2.500 | 2.50 | 13.5 | 9.38 | 11.88 |
| | 5.5 | 6.249 | 1.00 | 8.50 | 3.73 | 2.73 | .38 | 3.39 | 5.38 | 8.50 | 2.500 | 2.50 | 13.5 | 9.38 | 11.88 |
| 8 | 6 | 6.749 | 1.00 | 9.63 | 4.23 | 3.23 | .25 | 3.86 | 6.50 | 9.50 | 3.000 | 3.00 | 15.5 | 10.25 | 13.00 |
| | 6.5 | 7.249 | 1.00 | 9.63 | 4.23 | 3.23 | .38 | 3.39 | 6.50 | 9.50 | 3.000 | 3.00 | 15.5 | 10.25 | 13.00 |

TZ17 Head Trunnion Mounts (ANSI MT1)

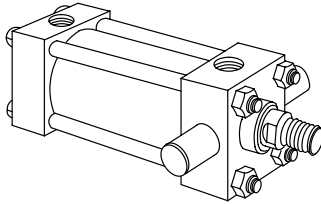

Either mount can be used both in compression (push) and tension (pull) applications. When used in compression applications, head trunnion mounts provide a longer maximum stroke than cap trunnion mounts.

NOTE

For strokes in excess of 24 inches, see "Stop tube selection" on page NO TAG.

an extremely tight fit to the mating machine member and permit curvilinear motion.

It is recommended that rigidly mounted pillow blocks with bearings at least as long as the trunnion pins be used. The pillow blocks should be installed as close to the shoulder of the trunnion as possible.

These mounts are for applications in which the machine member travels in a curved path in one plane.

The trunnion pins are an integral part of the head and can be sleeved to provide

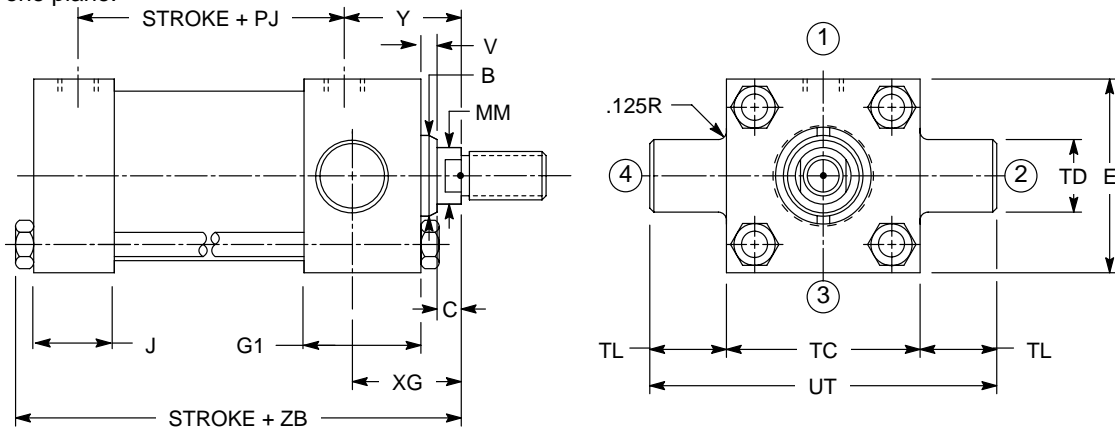

| Bore | Rod MM | ^{-0.001/-0.002} B | C | E | G1 | J | V | Y | PJ+ | TC | ^{-0.001/-0.002} TD | TL | UT | XG | Max ZB+ |
|------|-----------|-------------------------------|------|------|------|------|-----|------|------|------|--------------------------------|------|------|------|------------|
| 1½ | .625 | 1.124 | .38 | 2.50 | 2.23 | 1.48 | .25 | 2.06 | 2.87 | 2.50 | 1.000 | 1.00 | 4.50 | 1.88 | 6.00 |
| | 1 | 1.499 | .50 | 2.50 | 2.23 | 1.48 | .50 | 2.44 | 2.87 | 2.50 | 1.000 | 1.00 | 4.50 | 2.25 | 6.38 |
| 2 | 1 | 1.499 | .50 | 3.00 | 2.36 | 1.48 | .25 | 2.39 | 2.91 | 3.00 | 1.375 | 1.38 | 5.75 | 2.25 | 6.50 |
| | 1.375 | 1.999 | .63 | 3.00 | 2.36 | 1.48 | .38 | 2.64 | 2.91 | 3.00 | 1.375 | 1.38 | 5.75 | 2.50 | 6.75 |
| 2½ | 1 | 1.499 | .50 | 3.50 | 2.36 | 1.48 | .25 | 2.30 | 3.15 | 3.50 | 1.375 | 1.38 | 6.25 | 2.25 | 6.63 |
| | 1.375 | 1.999 | .63 | | | | .38 | 2.55 | | | | | | 2.50 | 6.88 |
| | 1.75 | 2.374 | .75 | | | | .50 | 2.80 | | | | | | 2.75 | 7.13 |
| 3¼ | 1.375 | 1.999 | .63 | 4.50 | 2.73 | 1.73 | .25 | 2.66 | 3.66 | 4.50 | 1.750 | 1.75 | 8.00 | 2.63 | 7.75 |
| | 1.75 | 2.374 | .75 | | | | .38 | 2.91 | | | | | | 2.88 | 8.00 |
| | 2 | 2.624 | .88 | | | | .38 | 3.03 | | | | | | 3.00 | 8.13 |
| 4 | 1.75 | 2.374 | .75 | 5.00 | 2.86 | 1.73 | .25 | 2.85 | 3.98 | 5.00 | 1.750 | 1.75 | 8.50 | 2.88 | 8.25 |
| | 2 | 2.624 | .88 | | | | .25 | 2.98 | | | | | | 3.00 | 8.38 |
| | 2.5 | 3.124 | 1.0 | | | | .38 | 3.23 | | | | | | 3.25 | 8.63 |
| 5 | 2 | 2.624 | .88 | 6.50 | 2.98 | 1.73 | .25 | 3.14 | 4.61 | 6.50 | 1.750 | 1.75 | 10.0 | 3.00 | 9.00 |
| | 2.5 | 3.124 | 1.0 | | | | .38 | 3.39 | | | | | | 3.25 | 9.25 |
| | 3 | 3.749 | 1.0 | | | | .38 | 3.39 | | | | | | 3.25 | 9.25 |
| | 3.5 | 4.249 | 1.0 | | | | .38 | 3.39 | | | | | | 3.25 | 9.25 |
| 6 | 2.5 | 3.124 | 1.00 | 7.50 | 3.23 | 2.23 | .25 | 3.50 | 4.88 | 7.50 | 2.000 | 2.00 | 11.5 | 3.38 | 10.63 |
| | 3 | 3.749 | | | | | | | | | | | | | |
| | 3.5 | 4.249 | | | | | | | | | | | | | |
| | 4 | 4.749 | | | | | | | | | | | | | |
| 7 | 3 | 3.749 | 1.00 | 8.50 | 3.73 | 2.73 | .25 | 3.81 | 5.38 | 8.50 | 2.500 | 2.50 | 13.5 | 3.63 | 11.88 |
| | 3.5 | 4.249 | | | | | | | | | | | | | |
| | 4 | 4.749 | | | | | | | | | | | | | |
| | 4.5 | 5.249 | | | | | | | | | | | | | |
| | 5 | 5.749 | | | | | | | | | | | | | |
| 8 | 3.5 | 4.249 | 1.00 | 9.62 | 4.23 | 2.98 | .25 | 3.86 | 6.50 | 9.50 | 3.000 | 3.00 | 15.5 | 3.75 | 13.00 |
| | 4 | 4.749 | | | | | | | | | | | | | |
| | 4.5 | 5.249 | | | | | | | | | | | | | |
| | 5 | 5.749 | | | | | | | | | | | | | |
| | 5.5 | 6.249 | | | | | | | | | | | | | |

TZ19 Centerline Lug Mounts (ANSI MS3)

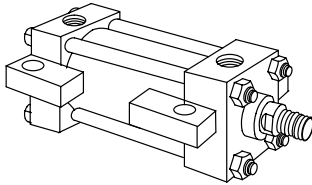

Centerline lug mounts are for moving loads along a flat guided surface as in a carriage along rails. The mounting surface should be flat and parallel to the centerline of the piston rod.

The load should be guided to traverse along the centerline of the piston rod.

The frame on which the cylinder is mounted must be sufficiently rigid to resist bending moments.

NOTE

Limit operating pressure to 1500 psi for minimum deflection. For strokes in excess of 30 inches, see "Stop tube selection" on page NO TAG.

With unsupported loads, the bearing must absorb more force. For these applications, the larger available rod is

recommended, and stop tubes should be considered.

Use high tensile socket head cap screws or hex head bolts tightened to the manufacturer's recommended torque.

For high shock applications, dowel pins or shear keys should be incorporated in the mounting design.

For severe side load applications, consult your local Vickers sales engineer.

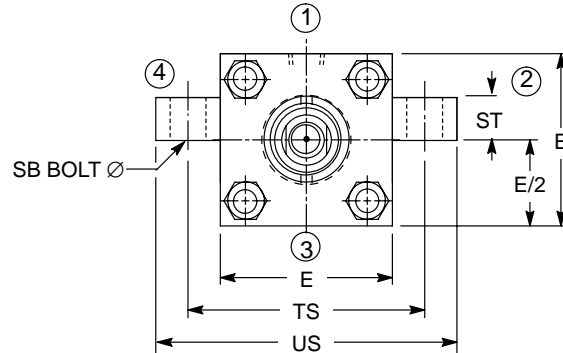
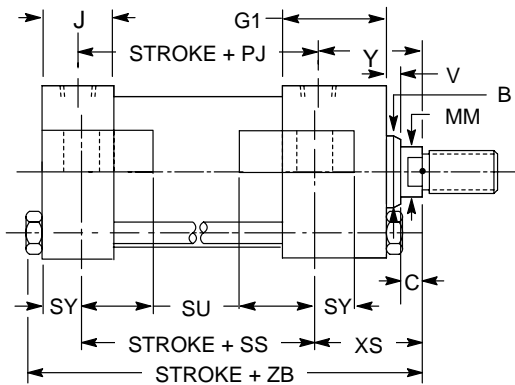

| Bore | Rod MM | ^{-0001/0002} B | C | E | G1 | J | V | Y | E/2 | PJ+ | SB | SS+ | ST | SU | SY | TS | US | XS | Max ZB+ |
|------|--------|-------------------------|------|------|------|------|-----|------|------|------|------|------|------|------|------|-------|------|------|---------|
| 1½ | .625 | 1.124 | .38 | 2.50 | 2.23 | 1.48 | .25 | 2.06 | 1.25 | 2.87 | .38 | 3.88 | .50 | .91 | .39 | 3.25 | 4.00 | 1.38 | 6.00 |
| | 1 | 1.499 | .50 | 2.50 | 2.23 | 1.48 | .50 | 2.44 | 1.25 | 2.87 | .38 | 3.88 | .50 | .91 | .39 | 3.25 | 4.00 | 1.75 | 6.38 |
| 2 | 1 | 1.499 | .50 | 3.00 | 2.36 | 1.48 | .25 | 2.39 | 1.50 | 2.91 | .50 | 3.63 | .75 | 1.24 | .51 | 4.00 | 5.00 | 1.88 | 6.50 |
| | 1.375 | 1.999 | .63 | 3.00 | 2.36 | 1.48 | .38 | 2.64 | 1.50 | 2.91 | .50 | 3.63 | .75 | 1.24 | .51 | 4.00 | 5.00 | 2.13 | 6.75 |
| 2½ | 1 | 1.499 | .50 | 3.50 | 2.36 | 1.48 | .25 | 2.30 | 1.75 | 3.15 | .75 | 3.38 | 1.00 | 1.56 | .68 | 4.88 | 6.25 | 2.06 | 6.63 |
| | 1.375 | 1.999 | .63 | 3.50 | 2.36 | 1.48 | .38 | 2.55 | 1.75 | 3.15 | .75 | 3.38 | 1.00 | 1.56 | .68 | 4.88 | 6.25 | 2.31 | 6.88 |
| 3¼ | 1.75 | 1.999 | .63 | 4.50 | 2.73 | 1.73 | .25 | 2.66 | 2.25 | 3.66 | .75 | 4.13 | 1.00 | 1.55 | .69 | 5.88 | 7.25 | 2.31 | 7.75 |
| | 2 | 2.374 | .75 | 4.50 | 2.73 | 1.73 | .38 | 2.91 | 2.25 | 3.66 | .75 | 4.13 | 1.00 | 1.55 | .69 | 5.88 | 7.25 | 2.56 | 8.00 |
| 4 | 1.75 | 2.374 | .75 | 5.00 | 2.86 | 1.73 | .25 | 2.85 | 2.50 | 3.98 | 1.00 | 4.00 | 1.25 | 2.00 | .87 | 6.75 | 8.50 | 2.75 | 8.25 |
| | 2 | 2.624 | .88 | 5.00 | 2.86 | 1.73 | .25 | 2.98 | 2.50 | 3.98 | 1.00 | 4.00 | 1.25 | 2.00 | .87 | 6.75 | 8.50 | 2.88 | 8.38 |
| 5 | 2.5 | 3.124 | 1.00 | 6.50 | 2.98 | 1.73 | .25 | 2.82 | 3.25 | 4.64 | 1.00 | 4.50 | 1.25 | 2.00 | .87 | 8.25 | 10.0 | 3.13 | 9.00 |
| | 3 | 3.749 | 1.00 | 6.50 | 2.98 | 1.73 | .38 | 3.06 | 3.25 | 4.64 | 1.00 | 4.50 | 1.25 | 2.00 | .87 | 8.25 | 10.0 | 3.13 | 9.25 |
| 6 | 3.5 | 4.249 | 1.00 | 7.50 | 3.23 | 2.23 | .25 | 3.22 | 3.75 | 5.36 | 1.25 | 5.13 | 1.50 | 2.50 | 1.12 | 9.75 | 12.0 | 3.38 | 10.63 |
| | 4 | 4.749 | 1.00 | 7.50 | 3.23 | 2.23 | .38 | 3.06 | 3.75 | 5.36 | 1.25 | 5.13 | 1.50 | 2.50 | 1.12 | 9.75 | 12.0 | 3.38 | 10.63 |
| 7 | 3 | 3.749 | 1.00 | 8.50 | 3.73 | 2.73 | .25 | 3.60 | 4.25 | 5.83 | 1.50 | 5.75 | 1.75 | 2.88 | 1.37 | 11.25 | 14.0 | 3.63 | 11.88 |
| | 3.5 | 4.249 | 1.00 | 8.50 | 3.73 | 2.73 | .38 | 3.60 | 4.25 | 5.83 | 1.50 | 5.75 | 1.75 | 2.88 | 1.37 | 11.25 | 14.0 | 3.63 | 11.88 |
| 8 | 4 | 4.749 | 1.00 | 9.63 | 4.23 | 2.98 | .25 | 3.86 | 4.81 | 6.50 | 1.50 | 6.75 | 1.75 | 2.88 | 1.37 | 12.25 | 15.0 | 3.63 | 13.00 |
| | 4.5 | 5.249 | 1.00 | 9.63 | 4.23 | 2.98 | .38 | 3.86 | 4.81 | 6.50 | 1.50 | 6.75 | 1.75 | 2.88 | 1.37 | 12.25 | 15.0 | 3.63 | 13.00 |

+ Plus stroke

TZ21 Cap Extended Tie Rod Mounts (ANSI MX2)

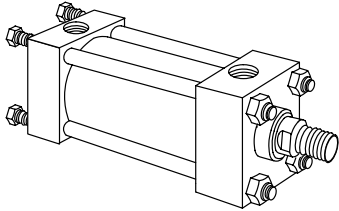

These mounts are for straight line force transfer applications. The cap extended tie rod mount is recommended for compression (pushing) applications.

The mounting surface should be flat and the frame on which the cylinder is mounted must be sufficiently rigid to resist bending moments.

Once fitted into the application framework, the nuts which are provided should be torqued to the values listed in the table (right).

NOTE

For strokes in excess of 30 inches, see "Stop tube selection" on page NO TAG.

Tie Rod Torque Values

Torque values in the following table apply to all mounting styles.

| Bore ∅ (in) | Tie Rod Torque* | |
|-------------------|-----------------|------|
| | (ft-lb) | (Nm) |
| 1 1/2 | 14 | 19 |
| 2 | 33 | 45 |
| 2 1/2 | 50 | 68 |
| 3 1/4 | 105 | 140 |
| 4 | 150 | 205 |
| 5 | 340 | 460 |
| 6 | 570 | 770 |
| 7 | 840 | 1140 |
| 8 | 1120 | 1520 |

* Recommended torque values using MoS₂ lubricant with 0,12 coefficient of friction.

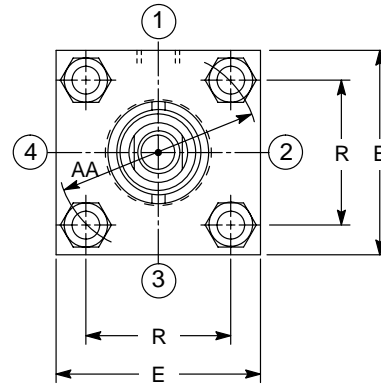
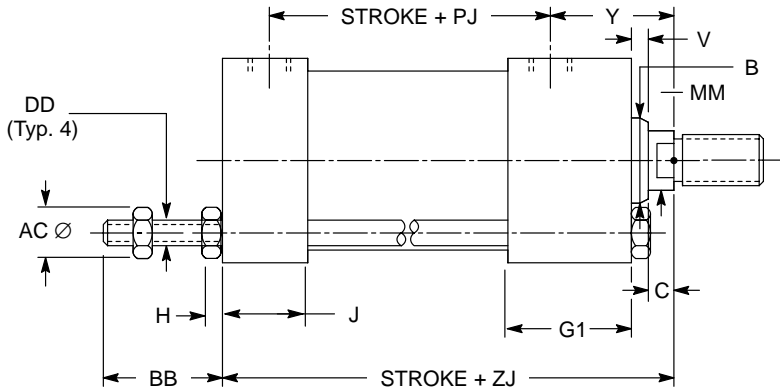

| Bore | Rod MM | ^{-0.000/-0.002} B | C | E | G1 | Max H | J | R | V | Y | AA | Max AC | BB | (UN) DD | PJ+ | ZJ+ |
|-------|--------|----------------------------|------|------|------|-------|------|------|-----|------|------|--------|------|------------|------|-------|
| 1 1/2 | .625 | 1.124 | .38 | 2.50 | 2.23 | .38 | 1.48 | 1.63 | .25 | 2.06 | 2.3 | .69 | 1.38 | 3/8 - 24 | 2.87 | 5.63 |
| | 1 | 1.499 | .50 | 2.50 | 2.23 | .38 | 1.48 | 1.63 | .50 | 2.44 | 2.3 | .69 | 1.38 | 3/8 - 24 | 2.87 | 6.00 |
| 2 | 1 | 1.499 | .50 | 3.00 | 2.36 | .50 | 1.48 | 2.05 | .25 | 2.39 | 2.9 | .88 | 1.81 | 1/2 - 20 | 2.91 | 6.00 |
| | 1.375 | 1.999 | .63 | 3.00 | 2.36 | .50 | 1.48 | 2.05 | .38 | 2.64 | 2.9 | .88 | 1.81 | 1/2 - 20 | 2.91 | 6.25 |
| 2 1/2 | 1 | 1.499 | .50 | 3.50 | 2.36 | .50 | 1.48 | 2.55 | .25 | 2.30 | 3.6 | .88 | 1.81 | 1/2 - 20 | 3.15 | 6.13 |
| | 1.375 | 1.999 | .63 | | | | | | .38 | 2.55 | | | | | | |
| 3 1/4 | 1.375 | 1.999 | .63 | 4.50 | 2.73 | .63 | 1.73 | 3.25 | .25 | 2.66 | 4.6 | 1.12 | 2.31 | 5/8 - 18 | 3.66 | 7.13 |
| | 1.75 | 2.374 | .75 | | | | | | .38 | 2.91 | | | | | | |
| 4 | 1.75 | 2.374 | .75 | 5.00 | 2.86 | .63 | 1.73 | 3.82 | .25 | 2.85 | 5.4 | 1.12 | 2.31 | 5/8 - 18 | 3.98 | 7.63 |
| | 2 | 2.624 | .88 | | | | | | .25 | 2.98 | | | | | | |
| 5 | 2 | 2.624 | .88 | 6.50 | 2.98 | .81 | 1.73 | 4.95 | .25 | 3.14 | 7.0 | 1.56 | 3.19 | 7/8 - 14 | 4.61 | 8.25 |
| | 2.5 | 3.124 | 1.00 | | | | | | .38 | 3.39 | | | | | | |
| 6 | 3 | 3.749 | 1.00 | 7.50 | 3.23 | .94 | 2.23 | 5.73 | .25 | 3.50 | 8.1 | 1.75 | 3.63 | 1 - 14 | 4.88 | 9.63 |
| | 3.5 | 4.249 | 1.00 | | | | | | .25 | 3.50 | | | | | | |
| 7 | 3 | 3.749 | 1.00 | 8.50 | 3.73 | 1.06 | 2.73 | 6.58 | .25 | 3.81 | 9.3 | 2.00 | 4.13 | 1 1/8 - 12 | 5.38 | 10.75 |
| | 3.5 | 4.249 | | | | | | | | | | | | | | |
| 8 | 4 | 4.749 | 1.00 | 9.63 | 4.23 | 2.12 | 2.98 | 7.50 | .25 | 3.86 | 10.6 | 2.19 | 4.50 | 1 1/4 - 12 | 6.50 | 11.75 |
| | 4.5 | 5.249 | | | | | | | | | | | | | | |
| | 5 | 5.749 | | | | | | | | | | | | | | |
| | 5.5 | 6.249 | | | | | | | | | | | | | | |

+ Plus stroke

TZ22 Head Extended Tie Rod Mounts (ANSI MX3)

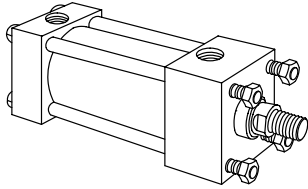

These mounts are for straight line force transfer applications. The head extended

tie rod mount is recommended for tension (pulling) applications.

The mounting surface should be flat and the frame on which the cylinder is mounted must be sufficiently rigid to resist bending moments.

On head mount applications, the cartridge provides a pilot diameter to align the rod in the mounting frame.

Once fitted into the application framework, the nuts which are provided should be torqued to the values listed in the table on the previous page.

NOTE

For strokes in excess of 30 inches, see "Stop tube selection" on page NO TAG.

The force on the rod should be perpendicular to the mounting surface and coincide with the centerline of the piston rod. For eccentric loads, the larger of the two available rods in each bore size is recommended. Stop tubes should also be considered.

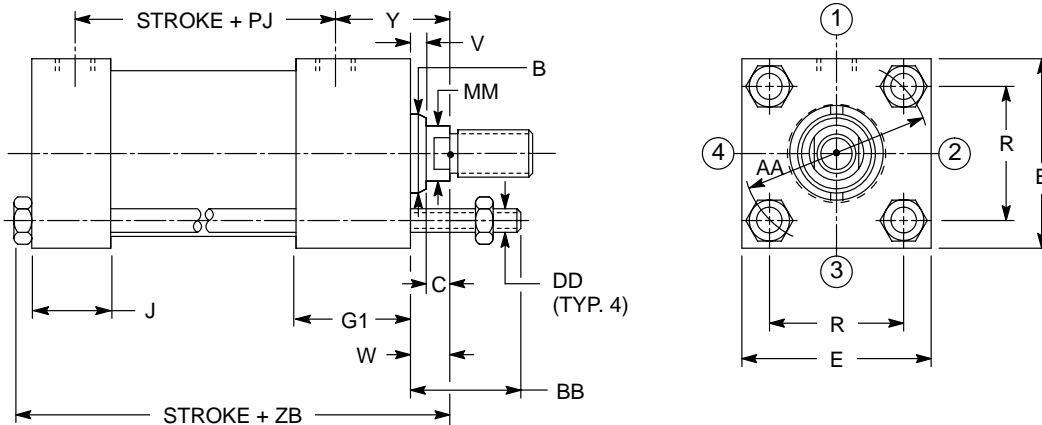

| Bore | Rod MM | ^{-0.000/-0.002} B | C | E | G1 | J | R | V | W | Y | AA | BB | (UN) DD | PJ+ | ZB+ |
|-------|--------|----------------------------|------|------|------|------|------|------|------|------|------|------|------------|------|-------|
| 1 1/2 | .625 | 1.124 | .38 | 2.50 | 2.23 | 1.48 | 1.63 | .25 | .63 | 2.06 | 2.3 | 1.38 | 3/8 - 24 | 2.87 | 6.00 |
| | 1 | 1.499 | .50 | 2.50 | 2.23 | 1.48 | 1.63 | .50 | 1.00 | 2.44 | 2.3 | 1.38 | 3/8 - 24 | 2.87 | 6.38 |
| 2 | 1 | 1.499 | .50 | 3.00 | 2.36 | 1.48 | 2.05 | .25 | .75 | 2.39 | 2.9 | 1.81 | 1/2 - 20 | 2.91 | 6.50 |
| | 1.375 | 1.999 | .63 | 3.00 | 2.36 | 1.48 | 2.05 | .38 | 1.00 | 2.64 | 2.9 | 1.81 | 1/2 - 20 | 2.91 | 6.75 |
| 2 1/2 | 1 | 1.499 | .50 | 3.50 | 2.36 | 1.48 | 2.55 | .25 | .75 | 2.30 | 3.6 | 1.81 | 1/2 - 20 | 3.15 | 6.63 |
| | 1.375 | 1.999 | .63 | | | | | 1.00 | 2.55 | | | | | | |
| | 1.75 | 2.374 | .75 | | | | | 1.25 | 2.80 | | | | | | |
| 3 1/4 | 1.375 | 1.999 | .63 | 4.50 | 2.73 | 1.73 | 3.25 | .25 | .88 | 2.66 | 4.6 | 2.31 | 5/8 - 18 | 3.66 | 7.75 |
| | 1.75 | 2.374 | .75 | | | | | 1.13 | 2.91 | | | | | | |
| | 2 | 2.624 | .88 | | | | | 1.25 | 3.03 | | | | | | |
| 4 | 1.75 | 2.374 | .75 | 5.00 | 2.86 | 1.73 | 3.82 | .25 | 1.00 | 2.85 | 5.4 | 2.31 | 5/8 - 18 | 3.98 | 8.25 |
| | 2 | 2.624 | .88 | | | | | 1.13 | 2.98 | | | | | | |
| | 2.5 | 3.124 | 1.00 | | | | | 1.38 | 3.23 | | | | | | |
| 5 | 2 | 2.624 | .88 | 6.50 | 2.98 | 1.73 | 4.95 | .25 | 1.13 | 3.14 | 7.0 | 3.19 | 7/8 - 14 | 4.61 | 9.00 |
| | 2.5 | 3.124 | 1.00 | | | | | 1.38 | 3.39 | | | | | | |
| | 3 | 3.749 | 1.00 | | | | | 1.38 | 3.39 | | | | | | |
| | 3.5 | 4.249 | 1.00 | | | | | 1.38 | 3.39 | | | | | | |
| 6 | 2.5 | 3.124 | 1.00 | 7.50 | 3.23 | 2.23 | 5.73 | .25 | 1.25 | 3.50 | 8.1 | 3.63 | 1 - 14 | 4.88 | 10.63 |
| | 3 | 3.749 | | | | | | | | | | | | | |
| | 3.5 | 4.249 | | | | | | | | | | | | | |
| | 4 | 4.749 | | | | | | | | | | | | | |
| 7 | 3 | 3.749 | 1.00 | 8.50 | 3.73 | 2.73 | 6.58 | .25 | 1.25 | 3.81 | 9.3 | 4.13 | 1 1/8 - 12 | 5.38 | 11.88 |
| | 3.5 | 4.249 | | | | | | | | | | | | | |
| | 4 | 4.749 | | | | | | | | | | | | | |
| | 4.5 | 5.249 | | | | | | | | | | | | | |
| 8 | 3.5 | 4.249 | 1.00 | 9.63 | 4.23 | 2.98 | 7.50 | .25 | 1.25 | 3.86 | 10.6 | 4.50 | 1 1/4 - 12 | 6.50 | 13.00 |
| | 4 | 4.749 | | | | | | | | | | | | | |
| | 4.5 | 5.249 | | | | | | | | | | | | | |
| | 5 | 5.749 | | | | | | | | | | | | | |
| | 5.5 | 6.249 | | | | | | | | | | | | | |

TZ23 Both Ends Extended Tie Rod Mounts (ANSI MX1)

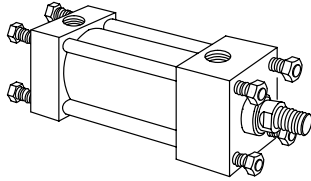

These mounts are for straight line force transfer applications. Both ends

extended tie rod mounts are suited for tension and compression applications or applications where additional hardware is to be attached to cylinders.

The mounting surface should be flat and the frame on which the cylinder is mounted must be sufficiently rigid to resist bending moments.

Once fitted into the application framework, the nuts which are provided should be torqued to the values listed in the table on page NO TAG.

NOTE

For strokes in excess of 30 inches, see "Stop tube selection" on page NO TAG.

The force on the rod should be perpendicular to the mounting surface and coincide with the centerline of the piston rod. For eccentric loads, the larger of the two available rods in each bore size is recommended. Stop tubes should also be considered.

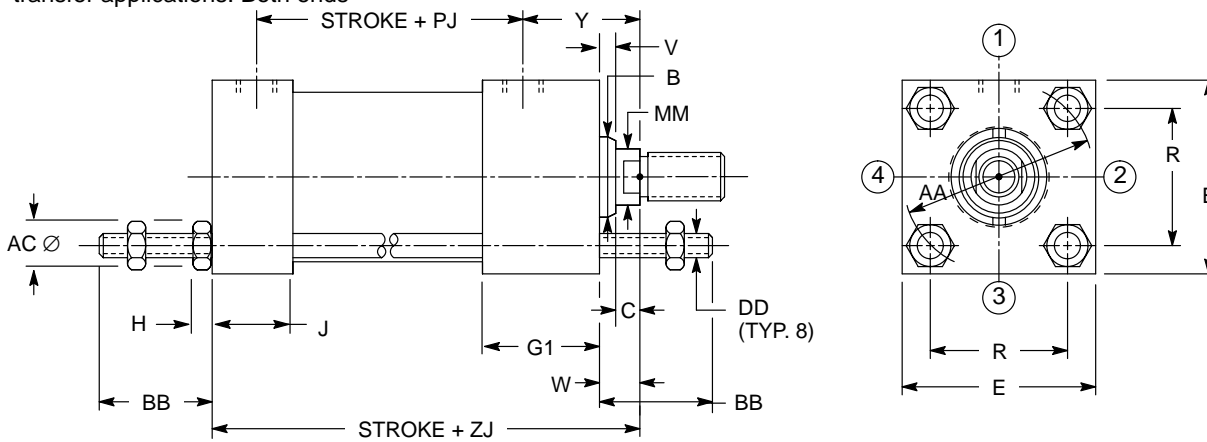

| Bore | Rod MM | ^{-0.000/-0.002} B | C | E | G1 | Max H | J | R | V | W | Y | AA | Max AC | BB | (UN) DD | PJ+ | ZJ+ |
|-------|--------|----------------------------|------|------|------|-------|------|------|-----|------|------|------|--------|------|------------|------|-------|
| 1 1/2 | .625 | 1.124 | .38 | 2.50 | 2.23 | .38 | 1.48 | 1.63 | .25 | .63 | 2.06 | 2.3 | .69 | 1.38 | 3/8 - 24 | 2.87 | 5.63 |
| | 1 | 1.499 | .50 | 2.50 | 2.23 | .38 | 1.48 | 1.63 | .50 | 1.00 | 2.44 | 2.3 | .69 | 1.38 | | | |
| 2 | 1 | 1.499 | .50 | 3.00 | 2.36 | .50 | 1.48 | 2.05 | .25 | .75 | 2.39 | 2.9 | .88 | 1.81 | 1/2 - 20 | 2.91 | 6.00 |
| | 1.375 | 1.999 | .63 | 3.00 | 2.36 | .50 | 1.48 | 2.05 | .38 | 1.00 | 2.64 | 2.9 | .88 | 1.81 | | | |
| 2 1/2 | 1 | 1.499 | .50 | 3.50 | 2.36 | .50 | 1.48 | 2.55 | .25 | .75 | 2.30 | 3.6 | .88 | 1.81 | 1/2 - 20 | 3.15 | 6.13 |
| | 1.375 | 1.999 | .63 | 3.50 | 2.36 | .50 | 1.48 | 2.55 | .38 | 1.00 | 2.55 | 3.6 | .88 | 1.81 | | | |
| 3 1/4 | 1.375 | 1.999 | .63 | 4.50 | 2.73 | .63 | 1.73 | 3.25 | .25 | .88 | 2.66 | 4.6 | 1.12 | 2.31 | 5/8 - 18 | 3.66 | 7.13 |
| | 1.75 | 2.374 | .75 | 4.50 | 2.73 | .63 | 1.73 | 3.25 | .38 | 1.13 | 2.91 | 4.6 | 1.12 | 2.31 | | | |
| 4 | 2 | 2.624 | .75 | 5.00 | 2.86 | .63 | 1.73 | 3.82 | .25 | 1.00 | 2.85 | 5.4 | 1.12 | 2.31 | 5/8 - 18 | 3.98 | 7.63 |
| | 2.5 | 3.124 | .88 | 5.00 | 2.86 | .63 | 1.73 | 3.82 | .25 | 1.13 | 2.98 | 5.4 | 1.12 | 2.31 | | | |
| 5 | 2 | 2.624 | .88 | 6.50 | 2.98 | .81 | 1.73 | 4.95 | .25 | 1.13 | 3.14 | 7.0 | 1.56 | 3.19 | 7/8 - 14 | 4.61 | 8.25 |
| | 2.5 | 3.124 | 1.00 | 6.50 | 2.98 | .81 | 1.73 | 4.95 | .38 | 1.38 | 3.39 | 7.0 | 1.56 | 3.19 | | | |
| 6 | 3 | 3.749 | 1.00 | 7.50 | 3.23 | .94 | 2.23 | 5.73 | .38 | 1.38 | 3.39 | 7.0 | 1.56 | 3.19 | 1 - 14 | 4.88 | 9.63 |
| | 3.5 | 4.249 | 1.00 | 7.50 | 3.23 | .94 | 2.23 | 5.73 | .38 | 1.38 | 3.39 | 7.0 | 1.56 | 3.19 | | | |
| 7 | 3 | 3.749 | 1.00 | 8.50 | 3.73 | 1.06 | 2.73 | 6.58 | .25 | 1.25 | 3.81 | 9.3 | 2.00 | 4.13 | 1 1/8 - 12 | 5.38 | 10.75 |
| | 3.5 | 4.249 | 1.00 | 8.50 | 3.73 | 1.06 | 2.73 | 6.58 | .25 | 1.25 | 3.81 | 9.3 | 2.00 | 4.13 | | | |
| 8 | 4 | 4.749 | 1.00 | 9.63 | 4.23 | 2.12 | 2.98 | 7.50 | .25 | 1.25 | 3.86 | 10.6 | 2.19 | 4.50 | 1 1/4 - 12 | 6.50 | 11.75 |
| | 4.5 | 5.249 | 1.00 | 9.63 | 4.23 | 2.12 | 2.98 | 7.50 | .25 | 1.25 | 3.86 | 10.6 | 2.19 | 4.50 | | | |

+ Plus stroke

TZ24 No Mount

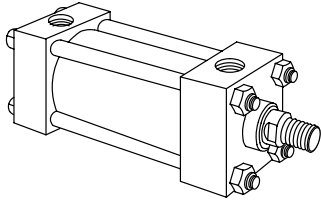

No mounts are for moving loads on a flat guided surface such as carriage rails.

Mounting surface should be flat and parallel to centerline of the piston rod.

The load should be guided to traverse along the centerline of the piston rod.

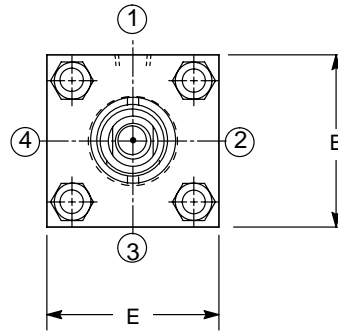
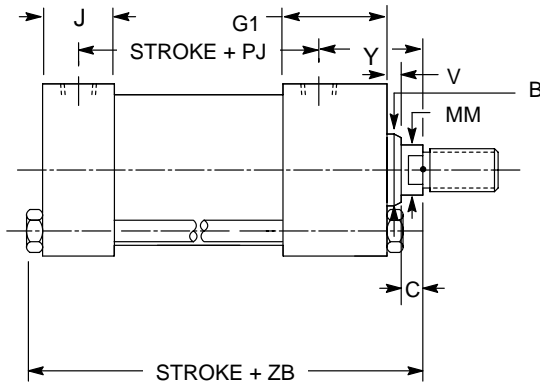

The frame on which the cylinder is mounted must be sufficiently rigid to resist bending moments.

NOTE

For strokes in excess of 30 inches, see "Stop tube selection" on page NO TAG.

With unsupported loads, the bearing must absorb more force. For these applications, the larger available rod is recommended, and stop tubes should be considered.

External clamping mechanism on head and cap is required to hold cylinder in place during operation.

Use high tensile socket head cap screws or hex head bolts tightened to the manufacturer's recommended torque in clamping.

For high shock applications, dowel pins or shear keys should be incorporated in the mounting design. For these applications, consider a keyed side lug mount, TZ04.

For severe side load applications, consult your local Vickers sales engineer.

| Bore | Rod MM | ^{-0.000/-0.002} B | C | E | G1 | J | V | Y | PJ+ | Max ZB+ | |
|------|-----------|-------------------------------|------|------|------|------|-----|------|------|------------|------|
| 1½ | .625 | 1.124 | .38 | 2.50 | 2.23 | 1.48 | .25 | 2.06 | 2.87 | 6.00 | |
| | 1 | 1.499 | .50 | 2.50 | 2.23 | 1.48 | .50 | 2.44 | 2.87 | 6.38 | |
| 2 | 1 | 1.499 | .50 | 3.00 | 2.36 | 1.48 | .25 | 2.39 | 2.91 | 6.50 | |
| | 1.375 | 1.999 | .63 | 3.00 | 2.36 | 1.48 | .38 | 2.64 | 2.91 | 6.75 | |
| 2½ | 1 | 1.499 | .50 | 3.50 | 2.36 | 1.48 | .25 | 2.30 | 3.15 | 6.63 | |
| | 1.375 | 1.999 | .63 | | | | .38 | 2.55 | | | 6.88 |
| | 1.75 | 2.374 | .75 | | | | .50 | 2.80 | | | 7.13 |
| 3¼ | 1.375 | 1.999 | .63 | 4.50 | 2.73 | 1.73 | .25 | 2.66 | 3.66 | 7.75 | |
| | 1.75 | 2.374 | .75 | | | | .38 | 2.91 | | 8.00 | |
| | 2 | 2.624 | .88 | | | | .38 | 3.03 | | 8.13 | |
| 4 | 1.75 | 2.374 | .75 | 5.00 | 2.86 | 1.73 | .25 | 2.85 | 3.98 | 8.25 | |
| | 2 | 2.624 | .88 | | | | .25 | 2.98 | | 8.38 | |
| | 2.5 | 3.124 | 1.00 | | | | .38 | 3.23 | | 8.63 | |
| 5 | 2 | 2.624 | .88 | 6.50 | 2.98 | 1.73 | .25 | 2.82 | 4.61 | 9.00 | |
| | 2.5 | 3.124 | 1.00 | | | | .38 | 3.06 | | 9.25 | |
| | 3 | 3.749 | 1.00 | | | | .38 | 3.06 | | 9.25 | |
| | 3.5 | 4.249 | 1.00 | | | | .38 | 3.06 | | 9.25 | |
| 6 | 2.5 | 3.124 | 1.00 | 7.50 | 3.23 | 2.23 | .25 | 3.22 | 4.88 | 10.63 | |
| | 3 | 3.749 | | | | | | | | | |
| | 3.5 | 4.249 | | | | | | | | | |
| | 4 | 4.749 | | | | | | | | | |

| | | | | | | | | | | |
|---|-----|-------|------|------|------|------|-----|------|------|-------|
| 7 | 3 | 3.749 | 1.00 | 8.50 | 3.73 | 2.73 | .25 | 3.60 | 5.38 | 11.88 |
| | 3.5 | 4.249 | | | | | | | | |
| | 4 | 4.749 | | | | | | | | |
| | 4.5 | 5.249 | | | | | | | | |
| 8 | 5 | 5.749 | 1.00 | 9.63 | 4.23 | 2.98 | .25 | 3.86 | 6.50 | 13.00 |
| | 3.5 | 4.249 | | | | | | | | |
| | 4 | 4.749 | | | | | | | | |
| | 4.5 | 5.249 | | | | | | | | |
| | 5 | 5.749 | | | | | | | | |
| | 5.5 | 6.249 | | | | | | | | |

+ Plus stroke

TZ25 Double Rod End, Side Lug Mounts

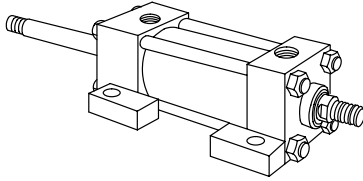

Double rod cylinders are specified when equal displacement is desired on both sides of the piston, or when the application is such that another function can be performed simultaneously with a second rod.

The single rod mount application data is also applicable to double rod cylinders.

Rod and pilot related dimensions are typical for both ends.

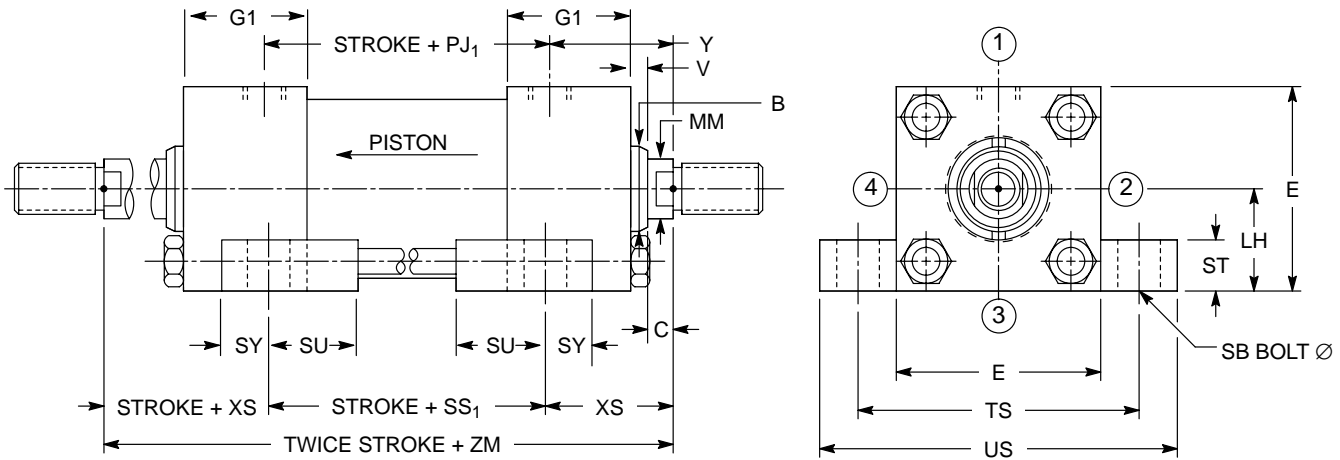

| Bore | Rod mm | ^{-0.001/-0.002} B | C | E | G1 | V | Y | ^{-0.001/-0.002} LH | PJ ₁ + | SB | SS ₁ + | ST | SU | SY | TS | US | XS | ZM++ |
|------|--------|----------------------------|------|------|------|-----|------|-----------------------------|-------------------|------|-------------------|------|------|------|-------|------|------|-------|
| 1½ | .625 | 1.124 | .38 | 2.50 | 2.23 | .25 | 2.06 | 1.25 | 2.87 | .38 | 4.13 | .50 | .75 | .31 | 3.25 | 4.00 | 1.38 | 6.88 |
| | 1 | 1.499 | .50 | 2.50 | 2.23 | .50 | 2.44 | 1.25 | 2.87 | .38 | 4.13 | .50 | .75 | .31 | 3.25 | 4.00 | 1.75 | 7.63 |
| 2 | 1 | 1.499 | .50 | 3.00 | 2.36 | .25 | 2.39 | 1.50 | 2.91 | .50 | 3.88 | .75 | .91 | .39 | 4.00 | 5.00 | 1.88 | 7.63 |
| | 1.375 | 1.999 | .63 | 3.00 | 2.36 | .38 | 2.64 | 1.50 | 2.91 | .50 | 3.88 | .75 | .91 | .39 | 4.00 | 5.00 | 2.13 | 8.38 |
| 2½ | 1 | 1.499 | .50 | 3.50 | 2.36 | .25 | 2.30 | 1.75 | 3.15 | .75 | 3.63 | 1.00 | .91 | .39 | 4.88 | 6.25 | 2.06 | 7.75 |
| | 1.375 | 1.999 | .63 | 3.50 | 2.36 | .38 | 2.55 | 1.75 | 3.15 | .75 | 3.63 | 1.00 | .91 | .39 | 4.88 | 6.25 | 2.31 | 8.25 |
| 3¼ | 1.75 | 2.374 | .75 | 4.50 | 2.73 | .50 | 2.80 | 2.50 | 3.66 | .75 | 4.38 | 1.00 | 1.30 | .47 | 5.88 | 7.25 | 2.56 | 8.75 |
| | 2 | 2.624 | .88 | 4.50 | 2.73 | .38 | 3.03 | 2.50 | 3.66 | .75 | 4.38 | 1.00 | 1.30 | .47 | 5.88 | 7.25 | 2.69 | 9.75 |
| 4 | 1.75 | 2.374 | .75 | 5.00 | 2.86 | .25 | 2.85 | 2.50 | 3.98 | 1.00 | 4.25 | 1.25 | 1.57 | .67 | 6.75 | 8.50 | 2.75 | 9.75 |
| | 2 | 2.624 | .88 | 5.00 | 2.86 | .25 | 2.98 | 2.50 | 3.98 | 1.00 | 4.25 | 1.25 | 1.57 | .67 | 6.75 | 8.50 | 2.88 | 10.00 |
| | 2.5 | 3.124 | 1.00 | 5.00 | 2.86 | .38 | 3.23 | 2.50 | 3.98 | 1.00 | 4.25 | 1.25 | 1.57 | .67 | 6.75 | 8.50 | 3.13 | 10.50 |
| 5 | 2 | 2.624 | .88 | 6.50 | 2.98 | .25 | 3.14 | 3.25 | 4.61 | 1.00 | 4.75 | 1.25 | 1.57 | .67 | 8.25 | 10.0 | 2.88 | 10.50 |
| | 2.5 | 3.124 | 1.00 | 6.50 | 2.98 | .38 | 3.39 | 3.25 | 4.61 | 1.00 | 4.75 | 1.25 | 1.57 | .67 | 8.25 | 10.0 | 3.13 | 11.00 |
| | 3 | 3.749 | 1.00 | 6.50 | 2.98 | .38 | 3.39 | 3.25 | 4.61 | 1.00 | 4.75 | 1.25 | 1.57 | .67 | 8.25 | 10.0 | 3.13 | 11.00 |
| | 3.5 | 4.249 | 1.00 | 6.50 | 2.98 | .38 | 3.39 | 3.25 | 4.61 | 1.00 | 4.75 | 1.25 | 1.57 | .67 | 8.25 | 10.0 | 3.13 | 11.00 |
| 6 | 2.5 | 3.124 | .88 | 7.50 | 3.23 | .25 | 3.50 | 3.75 | 4.88 | 1.25 | 5.13 | 1.50 | 2.00 | .87 | 9.75 | 12.0 | 3.38 | 11.88 |
| | 3 | 3.749 | 1.00 | 7.50 | 3.23 | .25 | 3.50 | 3.75 | 4.88 | 1.25 | 5.13 | 1.50 | 2.00 | .87 | 9.75 | 12.0 | 3.38 | 11.88 |
| | 3.5 | 4.249 | 1.00 | 7.50 | 3.23 | .25 | 3.50 | 3.75 | 4.88 | 1.25 | 5.13 | 1.50 | 2.00 | .87 | 9.75 | 12.0 | 3.38 | 11.88 |
| | 4 | 4.749 | 1.00 | 7.50 | 3.23 | .25 | 3.50 | 3.75 | 4.88 | 1.25 | 5.13 | 1.50 | 2.00 | .87 | 9.75 | 12.0 | 3.38 | 11.88 |
| 7 | 3 | 3.749 | .88 | 8.50 | 3.73 | .25 | 3.81 | 4.25 | 5.38 | 1.50 | 5.75 | 1.75 | 2.00 | .87 | 11.25 | 14.0 | 3.63 | 13.00 |
| | 3.5 | 4.249 | 1.00 | 8.50 | 3.73 | .25 | 3.81 | 4.25 | 5.38 | 1.50 | 5.75 | 1.75 | 2.00 | .87 | 11.25 | 14.0 | 3.63 | 13.00 |
| | 4 | 4.749 | 1.00 | 8.50 | 3.73 | .25 | 3.81 | 4.25 | 5.38 | 1.50 | 5.75 | 1.75 | 2.00 | .87 | 11.25 | 14.0 | 3.63 | 13.00 |
| | 4.5 | 5.249 | 1.00 | 8.50 | 3.73 | .25 | 3.81 | 4.25 | 5.38 | 1.50 | 5.75 | 1.75 | 2.00 | .87 | 11.25 | 14.0 | 3.63 | 13.00 |
| 8 | 4 | 4.749 | .88 | 9.63 | 4.23 | .25 | 3.86 | 4.75 | 6.50 | 1.50 | 6.75 | 1.75 | 2.48 | 1.14 | 12.25 | 15.0 | 3.63 | 14.00 |
| | 4.5 | 5.249 | 1.00 | 9.63 | 4.23 | .25 | 3.86 | 4.75 | 6.50 | 1.50 | 6.75 | 1.75 | 2.48 | 1.14 | 12.25 | 15.0 | 3.63 | 14.00 |
| | 5 | 5.749 | 1.00 | 9.63 | 4.23 | .25 | 3.86 | 4.75 | 6.50 | 1.50 | 6.75 | 1.75 | 2.48 | 1.14 | 12.25 | 15.0 | 3.63 | 14.00 |
| | 5.5 | 6.249 | 1.00 | 9.63 | 4.23 | .25 | 3.86 | 4.75 | 6.50 | 1.50 | 6.75 | 1.75 | 2.48 | 1.14 | 12.25 | 15.0 | 3.63 | 14.00 |

+ Plus Stroke ++ Plus 2x Stroke

Accessories

Rod Eye

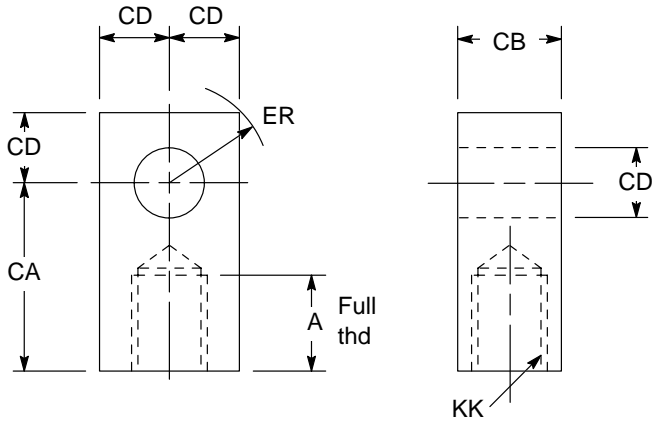

Swivel Pin (Includes two retaining rings)

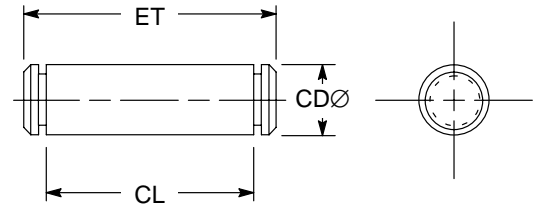

Mounting Eye Bracket (For clevis mount cylinders)

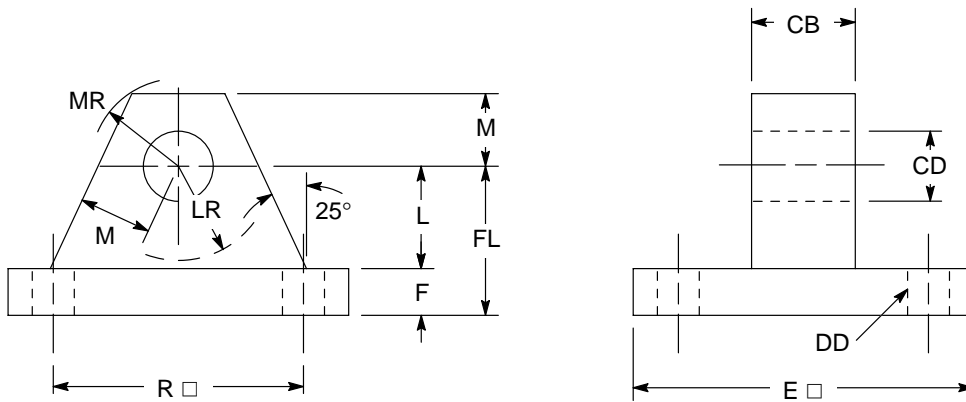

Rod Clevis (Includes swivel pin and retaining rings)

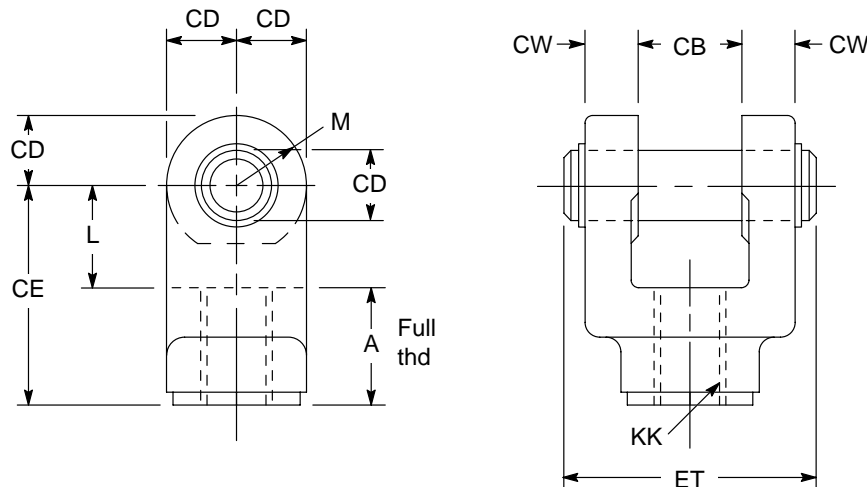

All rod accessories must be torqued against the rod shoulder.

Mounting brackets, rod clevises, and rod eyes for all TZ cylinders are available

from Vickers. These accessories are detailed below showing part numbers and all pertinent dimensional data. Make sure the rod end type selected has threads that match the threads of any

required accessory. Dimensions are in inches unless otherwise noted. When ordering, please specify the part name and part number.

Part Numbers, Weights, Thread Sizes, and Torques

| Bore Ø | Thread Size KK | Torque* | | Rod Eye | | Rod Clevis | | Eye Bracket | | Swivel Pin | |
|-----------|----------------------|---------|-------|----------------|-----------------|----------------|-----------------|----------------|-----------------|----------------|-----------------|
| | | (ft-lb) | (N-M) | Part Number | Weight (lbs) | Part Number | Weight (lbs) | Part Number | Weight (lbs) | Part Number | Weight (lbs) |
| 1 1/2 | 7/16-20 UNF-2B | 36 | 49 | S-1-560 | 0.38 | S-1-562-10 | 0.56 | S-1-552-M | 0.94 | TZ83050A-10 | 0.12 |
| 2, 2 1/2 | 3/4-16 UNF-2B | 125 | 169 | S-460 | 1.25 | S-462-10 | 1.56 | S-452-M | 3.19 | TZ83075A-10 | 0.38 |
| 3 1/4 | 1-14 NS-2B | 250 | 339 | S-660 | 2.50 | S-662-10 | 3.31 | TG780100 | 7.17 | TZ83100A-10 | 0.75 |
| 4 | 1 1/4-12 UNF-2B | 460 | 624 | S-1060 | 5.94 | S-1062-10 | 9.25 | S-1052-M | 11.7 | TZ83137A-10 | 1.88 |
| 5 | 1 1/2-12 UNF-2B | 663 | 900 | SH-560 | 11.4 | SH-562-10 | 14.62 | TG7801C0 | 22.0 | TZ83175A-10 | 3.88 |
| 6 | 1 7/8-12 UNF-2B | 944 | 1280 | SH-660 | 15.1 | SH-662-10 | 21.0 | TG780200 | 34.5 | TZ83200A-10 | 4.94 |
| 7 | 2 1/4-12 UNF-2B | 1315 | 1783 | SH-760 | 27.0 | SH-762-10 | 36.0 | TG780280 | 55.4 | TZ83250A-10 | 9.00 |
| 8 | 2 1/2-12 UNF-2B | 5050 | 6850 | SH-860 | 35.0 | SH-862-10 | 43.0 | TG780300 | 72.5 | TZ83300A-10 | 12.80 |

* Recommended torque values using MoS₂ lubricant with 0.12 coefficient of friction.

Dimensions

| Bore Ø (in) | A | E | F | L | M | R | CA | CB | CD | CE |
|-------------------|-------|-------|-------|-------|-------|------|---------|-------|-------|-------|
| 1 1/2 | 3/4 | 2 1/2 | 3/8 | 3/4 | 1/2 | 1.63 | 1 1/2 | 3/4 | 1/2 | 1 1/2 |
| 2, 2 1/2 | 1 1/8 | 3 1/2 | 5/8 | 1 1/4 | 3/4 | 2.55 | 2 1/16 | 1 1/4 | 3/4 | 2 3/8 |
| 3 1/4 | 1 5/8 | 4 1/2 | 7/8 | 1 1/2 | 1 | 3.25 | 2 13/16 | 1 1/2 | 1 | 3 1/8 |
| 4 | 2 | 5 | 7/8 | 2 1/8 | 1 3/8 | 3.82 | 3 7/16 | 2 | 1 3/8 | 4 1/8 |
| 5 | 2 1/4 | 6 1/2 | 1 1/8 | 2 1/4 | 1 3/4 | 4.95 | 4 | 2 1/2 | 1 3/4 | 4 1/2 |
| 6 | 3 | 7 1/2 | 1 1/2 | 2 1/2 | 2 | 5.73 | 5 | 2 1/2 | 2 | 5 1/2 |
| 7 | 3 1/2 | 8 1/2 | 1 3/4 | 3 | 2 1/2 | 6.58 | 5 13/16 | 3 | 2 1/2 | 6 1/2 |
| 8 | 3 1/2 | 9 1/2 | 2 | 3 1/4 | 2 3/4 | 7.50 | 6 1/8 | 3 | 3 | 6 3/4 |

| Bore Ø (in) | Min. CL | Max. CW | DD | ER | Min. ET | FL | KK | LR | MR |
|-------------------|------------|------------|-------|---------|------------|-------|-----------------|-------|--------|
| 1 1/2 | 1.83 | 1/2 | 3/8 | 45/64 | 2.16 | 1 1/8 | 7/16-20 UNF-2B | 11/16 | 19/32 |
| 2, 2 1/2 | 2.58 | 5/8 | 1/2 | 11/16 | 2.92 | 1 7/8 | 3/4-16 UNF-2B | 1 1/8 | 7/8 |
| 3 1/4 | 3.03 | 3/4 | 5/8 | 1 27/64 | 3.37 | 2 3/8 | 1-14 NS-2B | 1 3/8 | 1 1/4 |
| 4 | 4.03 | 1 | 5/8 | 1 15/16 | 4.44 | 3 | 1 1/4-12 UNF-2B | 1 7/8 | 1 5/8 |
| 5 | 5.03 | 1 1/4 | 7/8 | 2 15/16 | 5.52 | 3 3/8 | 1 1/2-12 UNF-2B | 2 | 1 7/8 |
| 6 | 5.03 | 1 1/4 | 1 | 2 13/16 | 5.56 | 4 | 1 7/8-12 UNF-2B | 2 1/4 | 2 3/32 |
| 7 | 6.03 | 1 1/2 | 1 1/8 | 3 17/32 | 6.68 | 4 3/4 | 2 1/4-12 UNF-2B | 2 3/4 | 2 5/8 |
| 8 | 6.03 | 1 1/2 | 1 1/4 | 4 1/4 | 6.78 | 5 1/4 | 2 1/2-12 UNF-2B | 3 | 2 7/8 |

Common Options Section

Rod End Types

In addition to selecting the correct bore, you must specify the appropriate rod size and rod end configuration for your application.

Twelve different inch and metric rod end configurations are available. If a custom design is required, contact your local Vickers sales engineer, and we will build to your requirements.

The table on page 10 gives maximum allowable push strokes at various operating pressures for available rod diameters of Series TZ cylinders. Rod ends on rigid mount cylinders should be supported. Longer strokes are allowable for **pull only** applications. Contact your local Vickers sales engineer for application assistance if necessary.

NOTE: Codes 0, 1, and N threads are to ISO 4395 and are based on the metric fine pitch series. Rod end accessories, locknuts, tooling, and gauging are readily available. These threads are also specified in ISO 6020-2 (160 bar compact) cylinder series. Codes 7 and L threads are based on the closest metric thread to the UN series and are recommended for replacement only.

Inch Rod Ends

| | | | |
|------------------|--|----------------------------------|--|
| Code 2 | | For rod sizes 3 1/2" thru 5 1/2" | |
| Code 5 | | Code K | |
| Code 6 | | Code G | |
| Code 9 | | Code M | |

Dimensions in inches

| Rod ∅ | | | | | | | | | | UN(F) Thread | | | |
|----------|-------|-----|-------|-------|---------|-------|--------|---------|------|--------------|----------|----------|------|
| | MM | A | C | D | AC | AD | AE | AF | AX | DC | CC | KK | NA |
| 0.625 | 3/4 | 3/8 | 1/2 | 1 1/8 | 5/8 | 1/4 | 3/8 | 1 1/8 | — | — | 1/2-20 | 7/16-20 | 0.56 |
| 1 | 1 1/8 | 1/2 | 7/8 | 1 5/8 | 15/16 | 3/8 | 1 1/16 | 1 11/16 | — | — | 7/8-14 | 3/4-16 | 0.91 |
| 1.375 | 1 5/8 | 5/8 | 1 1/8 | 1 3/4 | 1 1/16 | 3/8 | 7/8 | 2 7/16 | — | — | 1 1/4-12 | 1-14 | 1.31 |
| 1.75 | 2 | 3/4 | 1 1/2 | 2 | 1 5/16 | 1/2 | 1 1/8 | 3 | — | — | 1 1/2-12 | 1 1/4-12 | 1.63 |
| 2 | 2 1/4 | 7/8 | 1 3/4 | 2 5/8 | 1 11/16 | 5/8 | 1 3/8 | 3 3/8 | — | — | 1 3/4-12 | 1 1/2-12 | 1.88 |
| 2.5 | 3 | 1 | 2 1/8 | 3 1/4 | 1 15/16 | 3/4 | 1 3/4 | 4 1/2 | — | — | 2 1/4-12 | 1 7/8-12 | 2.38 |
| 3 | 3 1/2 | 1 | 2 5/8 | 3 5/8 | 2 7/16 | 7/8 | 2 1/4 | 5 1/4 | — | — | 2 3/4-12 | 2 1/4-12 | 2.88 |
| 3.5 | 3 1/2 | 1 | — | 4 3/8 | 2 11/16 | 1 | 2 1/2 | 5 1/4 | 3/8 | — | 3 1/4-12 | 2 1/2-12 | 3.38 |
| 4 | 4 | 1 | — | 4 1/2 | 2 11/16 | 1 | 3 | 6 | 7/16 | — | 3 3/4-12 | 3-12 | 3.88 |
| 4.5 | 4 1/2 | 1 | — | 5 1/4 | 3 3/16 | 1 1/2 | 3 1/2 | 6 3/4 | 7/16 | — | 4 1/4-12 | 3 1/4-12 | 4.38 |
| 5 | 5 | 1 | — | 5 3/8 | 3 3/16 | 1 1/2 | 3 7/8 | 7 1/2 | 1/2 | — | 4 3/4-12 | 3 1/2-12 | 4.88 |
| 5.5 | 5 1/2 | 1 | — | 6 1/4 | 3 15/16 | 1 7/8 | 4 3/8 | 8 1/4 | 1/2 | — | 5 1/4-12 | 4-12 | 5.38 |

Metric Rod Ends

| | | | | |
|------------------|--|----------------------------------|----------|--|
| Code 1 | | For rod sizes 3 1/2" thru 5 1/2" | | |
| Code 7 | | | L | |
| Code 0 | | | N | |

Dimensions in millimeters (except rod Ø)

Rod

| Ø MM (in) | A | C | D | AF | AX | DC | Metric Thread | | | |
|--------------|-----|------|----|-------|-----|-------|---------------|---------------|--------------|--------|
| | | | | | | | CC (ISO 4395) | KF (ISO 4395) | KK (ISO 261) | NA |
| 0.625 | 16 | 9,5 | 13 | 19,0 | 24 | — | M12 x 1,25 | M10 x 1,25 | M10 x 1,5 | 14,29 |
| 1 | 28 | 12,7 | 22 | 28,6 | 40 | — | ▲ | M20 x 1,5 | M20 x 1,5 | 23,81 |
| 1.375 | 36 | 15,9 | 30 | 41,3 | 54 | — | M27 x 2 | M27 x 2 | M26 x 1,5 | 33,34 |
| 1.75 | 45 | 19,0 | 36 | 50,8 | 66 | — | ▲ | M33 x 2 | M33 x 2 | 41,28 |
| 2 | 56 | 22,2 | 41 | 57,1 | 84 | — | M42 x 2 | M42 x 2 | M39 x 2 | 47,63 |
| 2.5 | 63 | 25,4 | 55 | 76,2 | 96 | — | ▲ | M48 x 2 | M48 x 2 | 60,33 |
| 3 | 85 | 25,4 | 65 | 88,9 | 128 | — | M64 x 3 | M58 x 2 | M58 x 2 | 73,03 |
| 3.5 | 85 | 25,4 | — | 88,9 | 128 | 9,52 | M64 x 3 | M64 x 3 | M64 x 2 | 85,73 |
| 4 | 95 | 25,4 | — | 101,6 | 140 | 11,11 | M80 x 3 | M80 x 3 | M76 x 2 | 98,43 |
| 4.5 | 106 | 25,4 | — | 114,3 | 158 | 11,11 | M90 x 3 | M90 x 3 | M80 x 2 | 111,13 |
| 5 | 112 | 25,4 | — | 139,7 | 168 | 12,70 | M100 x 3 | M100 x 3 | M90 x 2 | 123,83 |
| 5.5 | 112 | 25,4 | — | 139,7 | 168 | 12,70 | M100 x 3 | M100 x 3 | M100 x 2 | 136,53 |

▲ Intermediate male metric thread not available for 1, 1 3/4, and 2 1/2 inch rod sizes. Use codes 7 or L.

Port Type and Size

Available Ports

Series TZ cylinders are available with SAE straight thread O-ring ports and the alternate ports listed below.

The table below lists the port types and sizes available for each bore diameter. The table on the next page lists the maximum piston velocities obtainable with each bore diameter and port type combination.

Some mounting styles have port location restrictions. Check the port location table on page 4 for your particular mounting style. Where a port or port boss interferes with cylinder mounting, mounting should take precedence.

Code 3, 5 and A

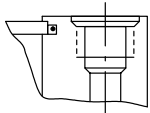

SAE straight thread O-ring seal port

Code 4 and B

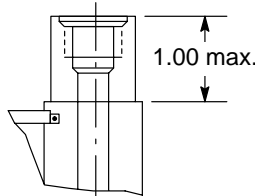

▲When boss is required

Code 6

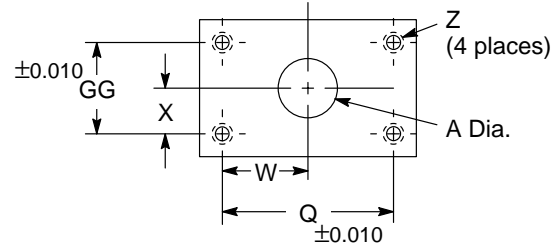

Code 1, 7, and 9

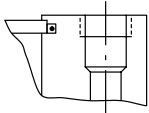

Code 2, 8, and 0

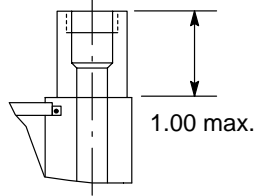

▲When boss is required

Dimensions in inches

| Flange Size | A | Q | W | X | Z | GG |
|-------------|------|-------|------|-----|---------|-------|
| 3/4 (-12) | .75 | 1.875 | .94 | .44 | 3/8-16 | .875 |
| 1 (-16) | 1.00 | 2.062 | 1.03 | .52 | 3/8-16 | 1.031 |
| 1 1/4 (-20) | 1.25 | 2.312 | 1.16 | .59 | 7/16-14 | 1.188 |
| 1 1/2 (-24) | 1.50 | 2.750 | 1.38 | .70 | 1/2-13 | 1.406 |

| Bore Ø (in) | Port Code | | | | | | | | | | |
|-------------------|---------------------------|--------|---|-----------------|-----------------|----------------|------------------------------|-------------------|---------|---------------------------|----------|
| | 1 | 2 | 3 | 4 | | 5 ^A | 6 | 7 ^D | 8 | 9 | 0 |
| | NPTF [†] Pipe | | SAE J1926 UN Thread O-ring / Thread Size | | | | SAE 518 Code 61 Flange | ISO 228-1 BSPP | | DIN 3852 Form X Metric | |
| 1 1/2 | 1/2 | 3/4▲ | 9/16-18 (-6) | 7/8-14 (-10) | 3/4-16 (-8) | - | - | G 1/2 | G 3/4▲ | M22 x 1.5 | M27 x 2▲ |
| 2 | 1/2 | 3/4▲ | 9/16-18 (-6) | 7/8-14 (-10) | 3/4-16 (-8) | - | - | G 1/2 | G 3/4▲ | M22 x 1.5 | M27 x 2▲ |
| 2 1/2 | 1/2 | 3/4▲ | 9/16-18 (-6) | 7/8-14 (-10) | 3/4-16 (-8) | - | - | G 1/2 | G 3/4▲ | M22 x 1.5 | M27 x 2▲ |
| 3 1/4 | 3/4 | 1▲ | 7/8-14 (-10) | 1 3/16-12 (-14) | 1 1/16-12 (-12) | 3/4 (-12) | G 3/4 | G 1▲ | M27 x 2 | M33 x 2▲ | |
| 4 | 3/4 | 1▲ | 7/8-14 (-10) | 1 3/16-12 (-14) | 1 1/16-12 (-12) | 3/4 (-12) | G 3/4 | G 1▲ | M27 x 2 | M33 x 2▲ | |
| 5 | 3/4 | 1▲ | 7/8-14 (-10) | 1 3/16-12 (-14) | 1 1/16-12 (-12) | 3/4 (-12) | G 3/4 | G 1▲ | M27 x 2 | M33 x 2▲ | |
| 6 | 1 | 1 1/4▲ | 1 1/16-12 (-12) | 1 5/8-12 (-20)▲ | 1 5/16-12 (-16) | 1 (-16) | G 1 | G 1 1/4▲ | M33 x 2 | M42 x 2▲ | |
| 7 | 1 1/4 | 1 1/2▲ | 1 5/16-12 (-16) | 1 7/8-12 (-24)▲ | 1 5/8-12 (-20) | 1 1/4 (-20) | G 1 1/4 | G 1 1/2▲ | M42 x 2 | M48 x 2▲ | |
| 8 | 1 1/2 | 2▲ | 1 5/16-12 (-16) | 1 5/8-12 (-20) | 1 7/8-12 (-24) | 1 1/2 (-24) | G 1 1/4 | G 1 1/2 | M48 x 2 | - | |

| Bore Ø (in) | Port Code | |
|-------------------|------------|----------|
| | A | B |
| | ISO 6149-1 | |
| 1 1/2 | M22 x 1.5 | M27 x 2▲ |
| 2 | M22 x 1.5 | M27 x 2▲ |
| 2 1/2 | M22 x 1.5 | M27 x 2▲ |
| 3 1/4 | M27 x 2 | M33 x 2▲ |
| 4 | M27 x 2 | M33 x 2▲ |
| 5 | M27 x 2 | M33 x 2▲ |
| 6 | M33 x 2 | M42 x 2▲ |
| 7 | M42 x 2 | M48 x 2▲ |
| 8 | M48 x 2 | - |

A - Size per ANSI B93.75M.
D - Conforms to DIN 24554.

* - Not available with 1.75 in rod diameter.
† - NPTF and BSPP ports are not recommended for maximum reliability on new applications.

Port Selection

Use this table to determine which bore diameter, rod diameter, and port combination will provide the piston velocity required for your application.

| Bore ∅ (in) | Rod ∅ (in) | Fluid Required per Inch of Stroke (gal) (in ³) | | Port Codes 1, 5, 6, 9 & A | | Port Codes 2, 4, 0 & B | | Port Code 3 | | Port Code 7 | | Port Code 8 | |
|-------------------|------------------|---|--------|------------------------------|------------------------------|---------------------------|------------------------------|---------------|------------------------------|---------------|------------------------------|---------------|------------------------------|
| | | | | Flow (gpm) | Piston Velocity (in/s) | Flow (gpm) | Piston Velocity (in/s) | Flow (gpm) | Piston Velocity (in/s) | Flow (gpm) | Piston Velocity (in/s) | Flow (gpm) | Piston Velocity (in/s) |
| 1 1/2 | Cap | 0.0084 | 1.948 | 6.0 | 11.8 | 9.2 | 18.1 | 6.0 | 11.8 | 3.4 | 6.8 | 9.2 | 18.1 |
| | 0.625 | 0.0071 | 1.641 | 6.0 | 14.0 | 9.2 | 21.5 | 6.0 | 14.0 | 3.4 | 8.1 | 9.2 | 21.5 |
| | 1 | 0.0050 | 1.162 | 6.0 | 19.8 | 9.2 | 30.4 | 6.0 | 19.8 | 3.4 | 11.4 | 9.2 | 30.4 |
| 2 | Cap | 0.0132 | 3.043 | 6.0 | 7.6 | 9.2 | 11.6 | 6.0 | 7.6 | 3.4 | 4.4 | 9.2 | 11.6 |
| | 1 | 0.0096 | 2.258 | 6.0 | 10.2 | 9.2 | 15.6 | 6.0 | 10.2 | 3.4 | 5.9 | 9.2 | 15.6 |
| | 1.375 | 0.0067 | 1.559 | 6.0 | 14.8 | 9.2 | 22.7 | 6.0 | 14.8 | 3.4 | 8.5 | 9.2 | 22.7 |
| 2 1/2 | Cap | 0.0209 | 4.832 | 6.0 | 4.8 | 9.2 | 7.3 | 6.0 | 4.8 | 3.4 | 2.8 | 9.2 | 7.3 |
| | 1 | 0.0175 | 4.046 | 6.0 | 5.7 | 9.2 | 8.7 | 6.0 | 5.7 | 3.4 | 3.3 | 9.2 | 8.7 |
| | 1.375 | 0.0145 | 3.347 | 6.0 | 6.9 | 9.2 | 10.6 | 6.0 | 6.9 | 3.4 | 4.0 | 9.2 | 10.6 |
| | 1.75 | 0.0105 | 2.427 | 6.0 | 9.5 | 9.2 | 14.6 | 6.0 | 9.5 | 3.4 | 5.5 | 9.2 | 14.6 |
| 3 1/4 | Cap | 0.0337 | 7.791 | 14.5 | 7.2 | 20.2 | 10.0 | 14.5 | 7.2 | 9.2 | 4.6 | 27.9 | 13.8 |
| | 1.375 | 0.0273 | 6.306 | 14.5 | 8.9 | 20.2 | 12.4 | 14.5 | 8.9 | 9.2 | 5.6 | 27.9 | 17.0 |
| | 1.75 | 0.0233 | 5.386 | 14.5 | 10.4 | 20.2 | 14.5 | 14.5 | 10.4 | 9.2 | 6.6 | 27.9 | 19.9 |
| | 2 | 0.0201 | 4.650 | 14.5 | 12.0 | 20.2 | 16.8 | 14.5 | 12.0 | 9.2 | 5.6 | 27.9 | 23.1 |
| 4 | Cap | 0.0527 | 12.174 | 14.5 | 4.6 | 20.2 | 6.4 | 14.5 | 4.6 | 9.2 | 2.9 | 27.9 | 8.8 |
| | 1.75 | 0.0423 | 9.768 | 14.5 | 5.7 | 20.2 | 8.0 | 14.5 | 5.7 | 9.2 | 3.6 | 27.9 | 11.0 |
| | 2 | 0.0391 | 9.032 | 14.5 | 6.2 | 20.2 | 8.6 | 14.5 | 6.2 | 9.2 | 3.9 | 27.9 | 11.9 |
| | 2.5 | 0.0315 | 7.265 | 14.5 | 7.7 | 20.2 | 10.7 | 14.5 | 7.7 | 9.2 | 4.9 | 27.9 | 14.8 |
| 5 | Cap | 0.0623 | 19.021 | 14.5 | 2.9 | 20.2 | 4.1 | 14.5 | 2.9 | 9.2 | 1.9 | 27.9 | 5.6 |
| | 2 | 0.0687 | 15.880 | 14.5 | 3.5 | 20.2 | 4.9 | 14.5 | 3.5 | 9.2 | 2.2 | 27.9 | 6.8 |
| | 2.5 | 0.0611 | 14.113 | 14.5 | 4.0 | 20.2 | 5.5 | 14.5 | 4.0 | 9.2 | 2.5 | 27.9 | 7.6 |
| | 3 | 0.0517 | 11.953 | 14.5 | 4.7 | 20.2 | 6.5 | 14.5 | 4.7 | 9.2 | 3.0 | 27.9 | 9.0 |
| | 3.5 | 0.0407 | 9.400 | 14.5 | 6.0 | 20.2 | 8.3 | 14.5 | 6.0 | 9.2 | 3.8 | 27.9 | 11.4 |
| 6 | Cap | 0.1224 | 28.274 | 27.9 | 3.8 | 45.5 | 6.2 | 27.9 | 3.8 | 14.5 | 2.0 | 45.5 | 6.2 |
| | 2.5 | 0.1011 | 23.366 | 27.9 | 4.6 | 45.5 | 7.5 | 27.9 | 4.6 | 14.5 | 2.4 | 45.5 | 7.5 |
| | 3 | 0.0918 | 21.206 | 27.9 | 5.1 | 45.5 | 8.3 | 27.9 | 5.1 | 14.5 | 2.6 | 45.5 | 8.3 |
| | 3.5 | 0.0807 | 18.653 | 27.9 | 5.8 | 45.5 | 9.4 | 27.9 | 5.8 | 14.5 | 3.0 | 45.5 | 9.4 |
| | 4 | 0.0680 | 15.708 | 27.9 | 6.8 | 45.5 | 11.2 | 27.9 | 6.8 | 14.5 | 3.6 | 45.5 | 11.2 |
| 7 | Cap | 0.1666 | 38.485 | 45.5 | 4.6 | 67.4 | 6.7 | 45.5 | 4.6 | 27.9 | 2.8 | 67.4 | 6.7 |
| | 3 | 0.1360 | 31.416 | 45.5 | 5.6 | 67.4 | 8.3 | 45.5 | 5.6 | 27.9 | 3.4 | 67.4 | 8.3 |
| | 3.5 | 0.1249 | 28.863 | 45.5 | 6.1 | 67.4 | 9.0 | 45.5 | 6.1 | 27.9 | 3.7 | 67.4 | 9.0 |
| | 4 | 0.1122 | 25.918 | 45.5 | 6.8 | 67.4 | 10.0 | 45.5 | 6.8 | 27.9 | 4.1 | 67.4 | 10.0 |
| | 4.5 | 0.0977 | 22.580 | 45.5 | 7.8 | 67.4 | 11.5 | 45.5 | 7.8 | 27.9 | 4.8 | 67.4 | 11.5 |
| | 5 | 0.0616 | 18.850 | 45.5 | 9.3 | 67.4 | 13.8 | 45.5 | 9.3 | 27.9 | 5.7 | 67.4 | 13.8 |
| 8 | Cap | 0.2106 | 48.695 | 67.4 | 5.3 | 45.5 | 3.6 | 45.5 | 3.6 | 27.9 | 2.2 | 67.4 | 5.3 |
| | 3.5 | 0.1692 | 39.074 | 67.4 | 6.6 | 45.5 | 4.5 | 45.5 | 4.5 | 27.9 | 2.7 | 67.4 | 6.6 |
| | 4 | 0.1564 | 36.128 | 67.4 | 7.2 | 45.5 | 4.8 | 45.5 | 4.8 | 27.9 | 3.0 | 67.4 | 7.2 |
| | 4.5 | 0.1420 | 32.791 | 67.4 | 7.9 | 45.5 | 5.3 | 45.5 | 5.3 | 27.9 | 3.3 | 67.4 | 7.9 |
| | 5 | 0.1258 | 29.060 | 67.4 | 8.9 | 45.5 | 6.0 | 45.5 | 6.0 | 27.9 | 3.7 | 67.4 | 8.9 |
| | 5.5 | 0.1080 | 24.937 | 67.4 | 10.4 | 45.5 | 7.0 | 45.5 | 7.0 | 27.9 | 4.3 | 67.4 | 10.4 |

Port Location

Port locations are identified by viewing the cylinder from the head end (or from the mounting end of double rod cylinders). The location numbers are shown here.

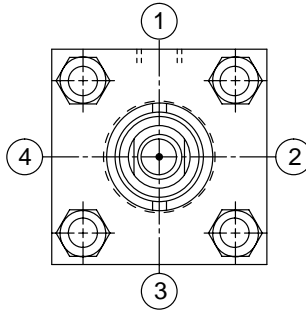

Certain port locations cannot be specified with some mounting styles. The table below indicates which of the head and cap port locations are available for each Series TZ mounting style.

| Mounting Style Code | Description | Head Locations | | | | Cap Locations | | | |
|---------------------|--|----------------|---|---|---|---------------|---|---|---|
| | | 1 | 2 | 3 | 4 | 1 | 2 | 3 | 4 |
| 01 | Side lug | A | N | A | N | A | N | A | N |
| 02 | Tapped | A | A | N | A | A | A | N | A |
| 04 | Keyed side lug | A | N | A | N | A | N | A | N |
| 05 | Keyed tapped | A | A | N | A | A | A | N | A |
| 07 | Head rectangular | A | A | A | A | A | A | A | A |
| 08 | Head square flange | W | W | W | W | A | A | A | A |
| 09 | Head rectangular flange | A | A | A | A | A | A | A | A |
| 10 | Clevis | A | A | A | A | A | A | A | A |
| 12 | Cap rectangular flange | A | A | A | A | A | W | A | W |
| 13 | Cap square flange | A | A | A | A | W | W | W | W |
| 14 | Cap rectangular | A | A | A | A | A | A | A | A |
| 15 | Intermediate trunnion | A | A | A | A | A | A | A | A |
| 16 | Cap trunnion | A | A | A | A | A | N | A | N |
| 17 | Head trunnion | A | N | A | N | A | A | A | A |
| 19 | Centerline lug | A | N | A | N | A | N | A | N |
| 21 | Cap extended tie rod | A | A | A | A | A | A | A | A |
| 22 | Head extended tie rod | A | A | A | A | A | A | A | A |
| 23 | Both ends extended tie rod | A | A | A | A | A | A | A | A |
| 24 | No mount | A | A | A | A | A | A | A | A |
| 25 | Double rod, side lug | A | N | A | N | | | | |
| 26 | Double rod, tapped | A | A | N | A | | | | |
| 28 | Double rod, keyed side lug | A | N | A | N | | | | |
| 29 | Double rod, keyed tapped | A | A | N | A | | | | |
| 31 | Double rod, rectangular flange | A | W | A | W | | | | |
| 32 | Double rod, square flange | W | W | W | W | | | | |
| 33 | Double rod, head rectangular | A | A | A | A | | | | |
| 34 | Double rod, intermediate trunnion | A | A | A | A | | | | |
| 35 | Double rod, head trunnion | A | N | A | N | | | | |
| 37 | Double rod, centerline lug | A | N | A | N | | | | |
| 39 | Double rod, extended tie rod | A | A | A | A | | | | |
| 40 | Double rod, both ends extended tie rod | A | A | A | A | | | | |
| 41 | Double rod, no mount | A | A | A | A | | | | |

A – Available
 N – Not available
 W – Port available without port boss only. Proximity switch not available. (Port codes 1, 3, 5, 7 and 9.)

Sealing Systems

Three different sealing systems are available in Series TZ cylinders.

Determine the correct seal code for your application, then enter it as item 8 in the model code.

| Code | Fluid | Temperature (°F) | Max. Speed (ft/s) | Application |
|----------|---|-------------------------|-------------------|---|
| N | Mineral oil, petroleum base Automotive transmission fluid | -31 to 176 | 2.25 | Normal, typical industrial |
| L | Mineral oil Water glycol (HFC) Oil-in-water emulsions (HFA) Water-in-oil emulsions (HFB) | -31 to 248 50 to 158 | 15 3 | Low friction servo Fire retardant fluids |
| T | Mineral oil Phosphate esters, petroleum oil blends Fyrquel 220, 550, 1000 Hought-O-Safe 1340 Pydraul 200, 230C, 280, 312C, 540C, A200 | -13 to 392 32 to 392 | 15 15 | High temperature Fire retardant fluids |

Gland Drain Option

Gland drains are primarily used for long stroke cylinders (over 30 inches) and when extended speed exceeds retract speed.

The gland drain is used to return any accumulated fluid, between the rod seal and wiper, to tank. This is used in servo applications, for ultra-low leakage requirements, or for remote visual monitoring of rod seal leakage for preventive maintenance purposes.

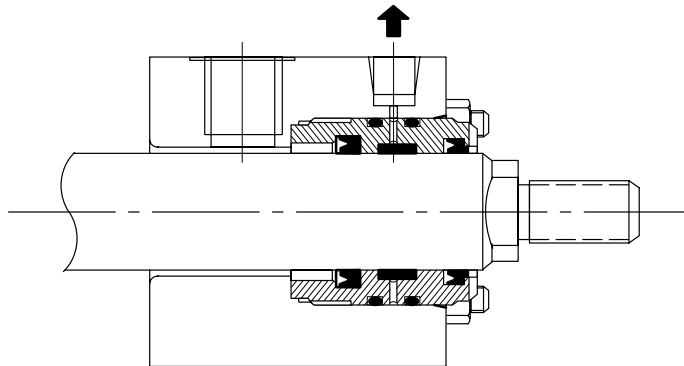

Air Bleed Option

Usually cylinders will bleed themselves of air when ports are vertical, on top. Bleed ports are often desirable to remove entrapped air, when the ports are on the bottom. High performance and high speed or heavy load applications are a few examples where air bleeds are desirable.

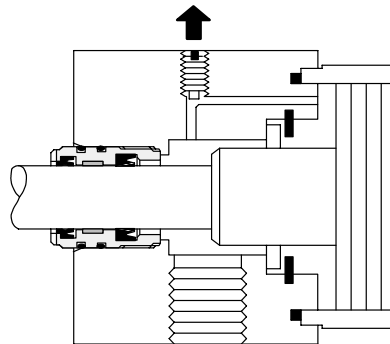

PS 200 Proximity Switches

PS 200 proximity switches for Series TZ cylinders are inductive type switches with a sensing probe that “looks” at the cushion collar or button to provide extend or retract indication. Since the probe is inside the cylinder, harsh external environments don’t affect sensing. The 2-wire circuit will operate on AC or DC and works as reliably as a programmable controller. PS 200 switches meet UL requirements for 3000

psi (210 bar) hydraulic cylinders. Vickers switch adaptor allows full 360° rotation.

Short Circuit Protection is a standard feature on the PS 200 Proximity Switch. SCP protects the switch from shorts in the load or line. Upon sensing a short condition, the switch assumes a non-conducting mode. The fault condition must be removed and power turned off in order to reset the switch. This feature prevents unintended

automatic restarts. The switch indicates when it is in SCP mode by flashing both LEDs.

Torque 1/4–20 mounting screws to 15 ft-lb (20 Nm).

O-rings required:

Size 115 – One per switch

Size 116 – One per spacer

Size 908 – One per adaptor

Series PS 200 2-wire AC/DC Proximity Switches

| | |
|-----------------------------------|---|
| Pressure | 3000 psi |
| Sensing range | 0.08 in ±10% |
| Sensing distance to end of stroke | 0.25 - 0.38 stroke to go. |
| Operating temperature range | -4° to +158°F |
| Repeatability | 0.001 in |
| Switching differential | 10% |
| Supply voltage | 20–220 V AC/DC |
| On-State voltage drop | 10V @ 5–500 mA |
| Load current man. | 0.5 Amp |
| Inrush current | 3 Amp |
| Quiescent current | 1.7 mA max. |
| Indicating LED's (standard) | 1 lit: Power on non-conducting 2 lit: Target present (both flashing = SCP mode) |

Dimensions in inches.

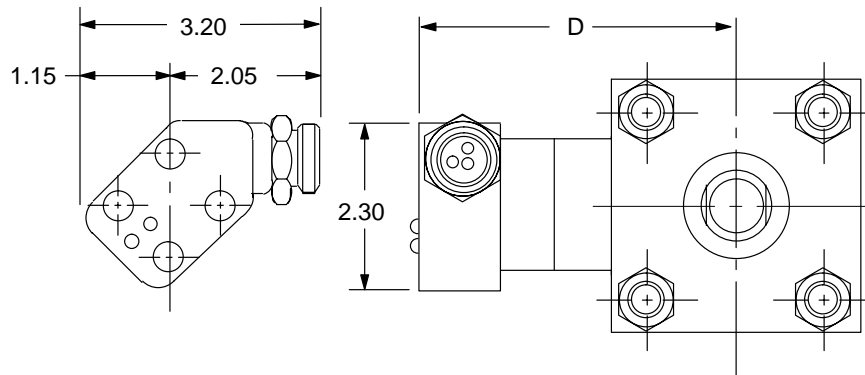

With the new Vickers switch adaptor, the proximity switch can rotate 360°. Use the chart on previous page for available proximity switch locations for the various mounting styles.

| Bore Ø | Rod Ø | Max. D | Max. D |
|-----------|----------|-----------|---------------------------------|
| | | | 09 & 14 Mounts pos. 2 & 4 |
| 1 1/2 | .625 | 3.44 | 4.58 |
| | 1 | 3.62 | 4.75 |
| | Cap | 3.69 | 4.83 |
| 2 | 1 | 3.67 | 4.81 |
| | 1.375 | 3.82 | 4.97 |
| | Cap | 3.82 | 4.97 |
| 2 1/2 | 1 | 4.31 | 4.97 |
| | 1.375 | 4.35 | 5.00 |
| | 1.75 | 3.98 | 5.13 |
| | Cap | 4.46 | 5.00 |
| 3 1/4 | 1.375 | 4.50 | 5.65 |
| | 1.75 | 4.50 | 5.65 |
| | 2 | 4.75 | 5.88 |
| | Cap | 4.52 | 5.88 |
| 4 | 1.75 | 5.19 | 6.56 |
| | 2 | 4.76 | 6.78 |
| | 2.5 | 5.00 | 6.15 |
| | Cap | 4.74 | 6.12 |
| | 5 | 2 | 5.41 |
| 6 | 2.5 | 5.65 | 7.03 |
| | 3 | 5.43 | 7.45 |
| | 3.5 | 5.43 | 7.45 |
| | Cap | 6.19 | 7.45 |
| | 2.5 | 6.19 | 7.88 |
| 7 | 3 | 6.09 | 8.27 |
| | 3.5 | 6.09 | 8.27 |
| | 4 | 6.32 | 8.50 |
| | Cap | 6.19 | 7.88 |
| | 3 | 6.58 | 8.69 |
| | 3.5 | 6.58 | 8.69 |
| | 4 | 6.58 | 8.75 |
| 8 | 4.5 | 6.58 | 8.75 |
| | 5 | 6.81 | 9.00 |
| | Cap | 7.17 | 8.69 |
| | 3.5 | 7.46 | 9.29 |
| | 4 | 6.98 | 9.29 |
| | 4.5 | 6.98 | 9.29 |
| | 5 | 7.12 | 9.29 |
| 5.5 | 7.12 | 9.29 | |
| Cap | 7.17 | 9.29 | |

Application / Engineering Data

Stop Tube Selection

The following table lists the maximum stroke permissible without the use of a stop tube. Strokes are listed for rigid mounting styles as well as clevis and trunnion pivot mounts.

As the stroke length of a cylinder increases, the resultant bearing loads on the piston rod become greater. To keep these bearing loads from exceeding design limitations, and to obtain optimum life from a cylinder, stop tubes should be specified according to the following procedure:

To order a stop tube, enter XXX for model code items 12, 13 and 14. Then specify the cylinder's working stroke and the required stop tube length. Specify 1 inch of stop tube for each 10 inches (or fraction thereof) of stroke in excess of the maximums listed in the table.

| Bore Ø (in) | Maximum Stroke (inches) | | |
|-------------------|-------------------------|---------------------------------|---------------|
| | Pivot Mounts | Rigid mounts Unsupported Rod | Supported Rod |
| 1.5 | 24 | 30 | 48 |
| 2 | 24 | 30 | 48 |
| 2.5 | 30 | 38 | 48 |
| 3.25 | 30 | 38 | 48 |
| 4 | 30 | 38 | 48 |
| 5 | 36 | 39 | 48 |
| 6 | 36 | 39 | 48 |
| 7 | 36 | 39 | 48 |
| 8 | 36 | 39 | 48 |

Stop Tube Designs

Three typical stop tube designs are illustrated below.

Design A

Used for cylinders not cushioned on the rod end.

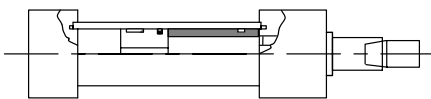

Design B

Used for cushioned hydraulic cylinders.

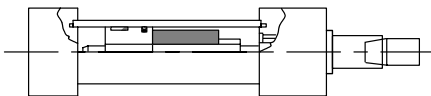

Design C

The best choice for a cylinder with an exceptionally long stop tube requirement. Note that the piston's effective bearing area is doubled, in addition to gaining the normal increased

minimum distance between bearing points.

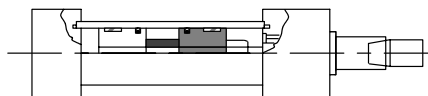

Tie Rod Spacers and Center Supports

A tie rod spacer or center support should be applied when the stroke length exceeds 20 times the bore diameter.

Tie rod spacer

Tie rod spacers and center supports are used to improve the structural rigidity of long stroke tie rod cylinders.

The spacers have through holes for the tie rods and are held in place on the cylinder barrel with a small tack weld or set screw.

The spacer keeps the tie rod in the proper position around the centerline of the cylinder and acts much like a truss in preventing excessive deflection in a long stroke cylinder that is not rigidly mounted (clevis mount, etc.).

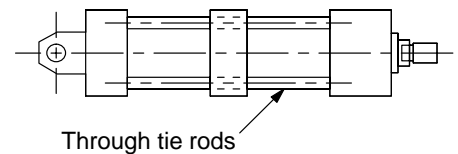

Tie rod center support

The center support has side mounting lugs similar to side lug mount heads and serves as an additional mounting location. The tie rods are threaded into the center support and it becomes a load-carrying component of the cylinder assembly.

The exact location of the tie rod center support is generally optional, which greatly increases the flexibility in mounting a long stroke cylinder.

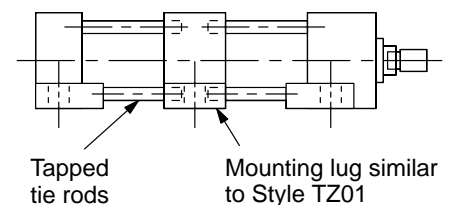

Bore & Rod Diameters

Cylinder Size Selection

To choose the proper size of cylinder for your application, first determine the maximum push and/or pull force required to do the job. Then use the

table below to select the cylinder that will provide that force. Remember that force capabilities derived from charts and formulas may be theoretically correct, but other factors must be considered. Be sure to allow for pressure drop between the pump outlet and the cylinder port. Also, some of a

cylinder's force is used up overcoming seal friction and, to a lesser extent, the inertia of the piston itself. In Vickers cylinders, the amount of extra force needed to compensate for these factors has been limited to 5% or less of the cylinder's theoretical power—without sacrificing sealing performance.

| Bore ∅ (in) | Rod ∅ (in) | Work Area (in ²) | Maximum Force (lb _f) At Working Pressure (psi) | | | | | |
|-------------------------------|------------------|------------------------------------|--|--------------|---------------|---------------|---------------|---------------|
| | | | 500 (psi) | 750 (psi) | 1000 (psi) | 1500 (psi) | 2000 (psi) | 3000 (psi) |
| 1 ¹ / ₂ | — | 1.948 | 974 | 1461 | 1948 | 2922 | 3896 | 5843 |
| | 0.625 | 1.641 | 820 | 1231 | 1641 | 2461 | 3282 | 4923 |
| | 1 | 1.162 | 581 | 872 | 1162 | 1744 | 2325 | 3487 |
| 2 | — | 3.043 | 1522 | 2283 | 3043 | 4565 | 6087 | 9130 |
| | 1 | 2.258 | 1129 | 1694 | 2258 | 3387 | 4516 | 6774 |
| | 1.375 | 1.559 | 779 | 1169 | 1559 | 2338 | 3117 | 4676 |
| 2 ¹ / ₂ | — | 4.832 | 2416 | 3624 | 4832 | 7248 | 9663 | 14495 |
| | 1 | 4.046 | 2023 | 3035 | 4046 | 6070 | 8093 | 12139 |
| | 1.375 | 3.347 | 1673 | 2510 | 3347 | 5020 | 6694 | 10041 |
| | 1.75 | 2.426 | 1213 | 1820 | 2426 | 3640 | 4853 | 7279 |
| 3 ¹ / ₄ | — | 7.791 | 3896 | 5843 | 7791 | 11687 | 15582 | 23373 |
| | 1.375 | 6.306 | 3153 | 4730 | 6306 | 9459 | 12613 | 18919 |
| | 1.75 | 5.386 | 2693 | 4039 | 5386 | 8079 | 10772 | 16158 |
| | 2 | 4.650 | 23325 | 3487 | 4650 | 6974 | 9299 | 13949 |
| 4 | — | 12.174 | 6087 | 9130 | 12174 | 18261 | 24347 | 36521 |
| | 1.75 | 9.768 | 4884 | 7326 | 9768 | 14653 | 19537 | 29305 |
| | 2 | 9.032 | 4516 | 6774 | 9032 | 13548 | 18064 | 27096 |
| | 2.5 | 7.265 | 3632 | 5449 | 7265 | 10897 | 14530 | 21795 |
| 5 | — | 19.021 | 9511 | 14266 | 19021 | 28532 | 38043 | 57064 |
| | 2 | 15.880 | 7940 | 11910 | 15880 | 23820 | 31760 | 47639 |
| | 2.5 | 14.113 | 7056 | 10584 | 14113 | 21169 | 28225 | 42338 |
| | 3 | 11.953 | 5976 | 8965 | 11953 | 17929 | 23906 | 35858 |
| | 3.5 | 9.400 | 4700 | 7050 | 9400 | 14100 | 18801 | 28201 |
| 6 | — | 28.274 | 14137 | 21206 | 28274 | 42412 | 56549 | 84823 |
| | 2.5 | 23.366 | 11683 | 17524 | 23366 | 35048 | 46731 | 70097 |
| | 3 | 21.206 | 10603 | 15904 | 21206 | 31809 | 42412 | 63617 |
| | 3.5 | 18.653 | 9327 | 13990 | 18653 | 27980 | 37306 | 55960 |
| | 4 | 15.708 | 7854 | 11781 | 15708 | 23562 | 31416 | 47124 |
| 7 | — | 38.485 | 19242 | 28863 | 38485 | 57727 | 76969 | 115454 |
| | 3 | 31.416 | 15708 | 23562 | 31416 | 47124 | 62832 | 94248 |
| | 3.5 | 28.863 | 14432 | 21648 | 28863 | 43295 | 57727 | 86590 |
| | 4 | 25.918 | 12959 | 19439 | 25918 | 38877 | 51836 | 77754 |
| | 4.5 | 22.580 | 11290 | 16935 | 22580 | 33870 | 45160 | 67741 |
| | 5 | 18.850 | 9425 | 14137 | 18850 | 28274 | 37699 | 56549 |
| 8 | — | 48.695 | 24347 | 36521 | 48695 | 73042 | 97390 | 146084 |
| | 3.5 | 39.074 | 19537 | 29305 | 39074 | 58610 | 78147 | 117221 |
| | 4 | 36.128 | 18064 | 27096 | 36128 | 54193 | 72257 | 108385 |
| | 4.5 | 32.790 | 16395 | 24593 | 32790 | 49186 | 65581 | 98371 |
| | 5 | 29.060 | 14530 | 21795 | 29060 | 43590 | 58120 | 87179 |
| | 5.5 | 24.936 | 12468 | 18702 | 24936 | 37405 | 49873 | 74809 |

Maximum Allowable Push Strokes

In push applications, a cylinder acts as a loaded column.

To use the table below, first go to the section for your mounting style. Then

locate the column which is closest to, but not below, your application's operating pressure. The intersection of operating pressure and the bore/rod size represents the maximum allowable push stroke. This maximum stroke is based on column loading analysis only

and does not consider side loading, stop tube requirements, or other cylinder stroke limiters.

For pressures above 3000 psi, consult your local Vickers representative.

| Bore Rod Ø Ø (in) (in) | | Maximum Stroke (in) at Working Pressure (psi) | | | | | | | | | | | | | | | | | |
|------------------------------|-------|---|-------|-------|-------|-------|-------|-------------------------------|-------|-------|-------|---|-------|-------|-------|-------|-------|-------|-------|
| | | Rigid Mounts (01, 02, 04, 05, 07, 08, 09, 12, 13, 14, 19, 21, 22, 23, 24, 25, 26, 28, 29, 31, 32, 33, 37, 39, and 40) | | | | | | Cap Swivel Mounts (10 and 16) | | | | Intermediate Trunnion Mounts (15, 17, 34, and 35) | | | | | | | |
| | | 500 | 750 | 1000 | 1500 | 2000 | 3000 | 500 | 750 | 1000 | 1500 | 2000 | 3000 | 500 | 750 | 1000 | 1500 | 2000 | 3000 |
| | | (psi) | (psi) | (psi) | (psi) | (psi) | (psi) | (psi) | (psi) | (psi) | (psi) | (psi) | (psi) | (psi) | (psi) | (psi) | (psi) | (psi) | (psi) |
| 1 1/2 | 0.625 | 29 | 23 | 19 | 13 | 10 | 3 | 13 | 10 | 8 | 6 | 4 | 1 | 16 | 12 | 10 | 7 | 5 | 2 |
| | 1 | 79 | 64 | 54 | 43 | 36 | 26 | 35 | 28 | 24 | 19 | 16 | 12 | 42 | 34 | 29 | 23 | 19 | 14 |
| 2 | 1 | 62 | 49 | 42 | 32 | 26 | 17 | 28 | 22 | 19 | 14 | 11 | 8 | 33 | 26 | 22 | 17 | 14 | 9 |
| | 1.375 | 121 | 97 | 83 | 66 | 55 | 42 | 54 | 43 | 37 | 29 | 25 | 19 | 64 | 52 | 44 | 35 | 29 | 22 |
| 2 1/2 | 1 | 48 | 37 | 31 | 22 | 16 | 6 | 21 | 17 | 14 | 10 | 7 | 3 | 26 | 20 | 16 | 12 | 9 | 3 |
| | 1.375 | 94 | 75 | 64 | 49 | 40 | 29 | 42 | 33 | 28 | 22 | 18 | 13 | 50 | 40 | 34 | 26 | 22 | 15 |
| | 1.75 | 155 | 125 | 107 | 85 | 71 | 54 | 69 | 56 | 47 | 38 | 32 | 24 | 83 | 67 | 57 | 45 | 38 | 29 |
| 3 1/4 | 1.375 | 72 | 57 | 47 | 35 | 27 | 15 | 32 | 25 | 21 | 15 | 12 | 6 | 39 | 30 | 25 | 19 | 14 | 8 |
| | 1.75 | 120 | 96 | 81 | 63 | 52 | 37 | 53 | 43 | 36 | 28 | 23 | 16 | 64 | 51 | 43 | 34 | 18 | 20 |
| | 2 | 159 | 127 | 108 | 85 | 71 | 53 | 71 | 57 | 48 | 38 | 32 | 24 | 85 | 68 | 58 | 46 | 38 | 28 |
| 4 | 1.75 | 94 | 74 | 61 | 46 | 35 | 20 | 42 | 33 | 27 | 20 | 16 | 9 | 50 | 39 | 33 | 24 | 19 | 11 |
| | 2 | 125 | 99 | 83 | 64 | 51 | 35 | 55 | 44 | 37 | 28 | 23 | 15 | 66 | 53 | 44 | 34 | 27 | 18 |
| | 2.5 | 198 | 159 | 136 | 107 | 89 | 66 | 88 | 71 | 60 | 47 | 39 | 29 | 106 | 85 | 72 | 57 | 47 | 35 |
| 5 | 2 | 97 | 75 | 62 | 45 | 33 | 13 | 43 | 33 | 28 | 20 | 15 | 6 | 52 | 40 | 33 | 24 | 18 | 7 |
| | 2.5 | 156 | 124 | 104 | 80 | 64 | 43 | 69 | 55 | 46 | 35 | 29 | 19 | 83 | 66 | 56 | 43 | 34 | 23 |
| | 3 | 228 | 183 | 155 | 122 | 101 | 74 | 101 | 81 | 69 | 54 | 45 | 33 | 122 | 97 | 83 | 65 | 54 | 40 |
| | 3.5 | 313 | 252 | 215 | 171 | 144 | 110 | 139 | 112 | 96 | 76 | 64 | 49 | 167 | 135 | 115 | 91 | 77 | 59 |
| 6 | 2.5 | 124 | 97 | 80 | 58 | 44 | 20 | 55 | 43 | 36 | 26 | 19 | 9 | 66 | 52 | 43 | 31 | 23 | 11 |
| | 3 | 184 | 146 | 122 | 93 | 75 | 50 | 82 | 65 | 54 | 42 | 33 | 22 | 98 | 78 | 65 | 50 | 40 | 27 |
| | 3.5 | 253 | 203 | 172 | 134 | 111 | 80 | 113 | 90 | 76 | 60 | 49 | 36 | 135 | 108 | 92 | 72 | 59 | 43 |
| | 4 | 334 | 269 | 229 | 181 | 151 | 114 | 149 | 120 | 102 | 81 | 67 | 51 | 178 | 143 | 122 | 97 | 81 | 61 |
| 7 | 3 | 154 | 121 | 100 | 74 | 56 | 29 | 69 | 54 | 44 | 33 | 25 | 13 | 82 | 64 | 53 | 39 | 30 | 15 |
| | 3.5 | 214 | 170 | 143 | 109 | 87 | 58 | 95 | 76 | 63 | 48 | 39 | 26 | 114 | 91 | 76 | 58 | 47 | 31 |
| | 4 | 283 | 226 | 192 | 149 | 123 | 88 | 126 | 101 | 85 | 66 | 55 | 39 | 151 | 121 | 102 | 80 | 66 | 47 |
| | 4.5 | 362 | 290 | 247 | 195 | 162 | 122 | 161 | 129 | 110 | 87 | 72 | 54 | 193 | 155 | 132 | 104 | 87 | 65 |
| | 5 | 449 | 362 | 309 | 246 | 207 | 158 | 200 | 161 | 138 | 109 | 92 | 70 | 240 | 193 | 165 | 131 | 110 | 84 |
| 8 | 3.5 | 188 | 147 | 123 | 91 | 71 | 40 | 83 | 66 | 55 | 41 | 31 | 18 | 100 | 79 | 65 | 49 | 38 | 21 |
| | 4 | 249 | 198 | 166 | 127 | 103 | 69 | 111 | 88 | 74 | 57 | 46 | 31 | 133 | 106 | 89 | 68 | 55 | 37 |
| | 4.5 | 319 | 255 | 216 | 168 | 138 | 100 | 142 | 113 | 96 | 75 | 61 | 44 | 170 | 136 | 115 | 90 | 74 | 53 |
| | 5 | 397 | 318 | 271 | 213 | 178 | 132 | 176 | 142 | 121 | 95 | 79 | 59 | 212 | 170 | 145 | 114 | 95 | 71 |
| | 5.5 | 483 | 389 | 332 | 263 | 221 | 168 | 215 | 173 | 148 | 117 | 98 | 75 | 258 | 207 | 177 | 140 | 118 | 90 |

Cushioning System

Vickers cylinders have standard features that are extra cost options or not available on other look-alike NFPA/ANSI cylinders. Series TZ hydraulic cylinders are available with a patented floating ring cushion seal or alternate solid design with check valve that provide positive cushion sealing with minimum wear and maximum piston acceleration on the return stroke.

Advanced Cushions Provide Faster Cycle Times

Cylinder cushions are designed to decelerate the piston velocity near the end of each cylinder stroke to prevent excessive mechanical shock.

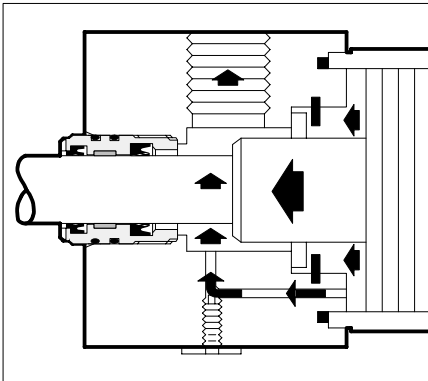

To accomplish this, the cushion collar contacts a floating sleeve or cylinder head which permits a very close seal contact without high loading. The sleeve seats against the head and provides a very effective seal to trap the fluid. Consistent performance and long life are provided.

Vickers advanced cushions permit higher cylinder speed, shorter cycle time, and more work per hour.

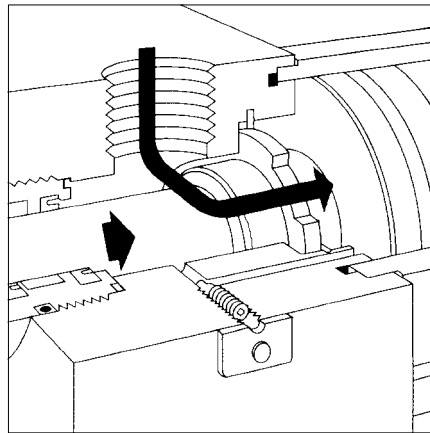

The sleeve design used on bore sizes under four inches, is also free to move in an axial direction and functions as a fluid check. When the fluid flow is reversed, the sleeve moves off its seat, and fluid flows around the slots in the outer sleeve's diameter permitting nearly full flow for quick acceleration.

Cushion Features

- Cushion design provides consistent long wearing seal between cushion collar and head.
- Floating design self-aligns to minimize wear.
- Check valve action of sleeve provides rapid acceleration out of the cushion.

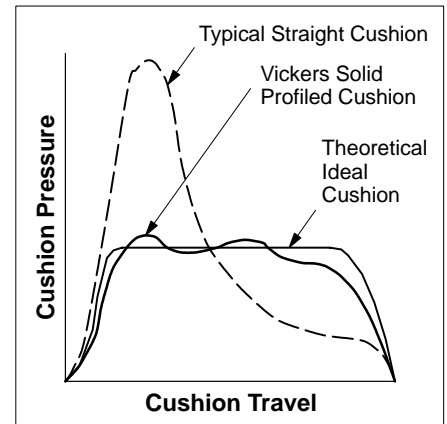

Cushions are recommended when piston speed exceeds 5 in/s. Any heavy loads attached to the piston rod should be absorbed by external means such as shock absorbers or springs.

Application Data

Cushioning System

Key Assumptions & Limitations

These assumptions provide parameters for determining maximum cushion performance. Actual performance may be different than determined by these methods, particularly if assumptions are not maintained.

Efficiency factors are applied to the energy calculations that attempt to reflect characteristics of the Vickers cushion design.

The following assumptions should be considered when calculating cushion capacity:

- Maximum cushion pressure is 310 bar (4500 psi).
- The upper limit of velocity is 18 in/s.
- If velocity is below 4 in/s, the cushions become ineffective on cylinders smaller than 2.5 in bore.
- Friction force is assumed to be zero.
- The cylinder is used in a linear system (not for rotary applications).
- Fluid viscosity is equivalent to 25 centistoke.
- The driving pressure is equal to the maximum system pressure, usually the relief valve setting.
- Cushion adjustment screws are provided to tune cushion performance within limits.
- Cushion efficiency (C_{eff}) is 0.67 for velocities between 4 and 12 in/sec or 0.1 and 0.3 m/sec., or 0.5 for velocities between 12 and 18 in/sec. or 0.3 and 0.5 m/sec.

Application 1



Application 2

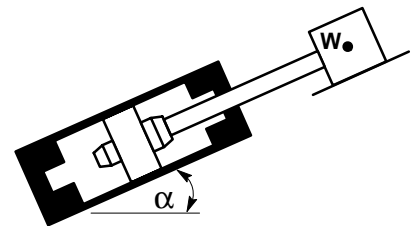

Application 3

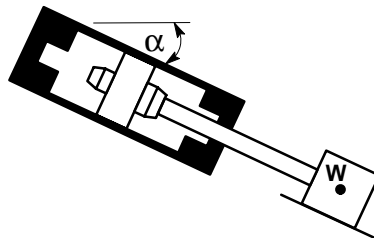

Application 1:

$$E = (1/C_{eff}) \{ [0.5 (W/386.1) V^2] \text{ extend or retract} \}$$

Application 2:

$$E = (1/C_{eff}) \{ [0.5 (W/386.1) V^2] - [W L_{hc} \sin(\alpha)] \} \text{ extend}$$

$$E = (1/C_{eff}) \{ [0.5 (W/386.1) V^2] + [W L_{cc} \sin(\alpha)] \} \text{ retract}$$

Application 3:

$$E = (1/C_{eff}) \{ [0.5 (W/386.1) V^2] + [W L_{hc} \sin(\alpha)] \} \text{ extend}$$

$$E = (1/C_{eff}) \{ [0.5 (W/386.1) V^2] - [W L_{cc} \sin(\alpha)] \} \text{ retract}$$

Calculations for TZ Cylinder

Units (US)

| | | |
|-------|---------------------|---------------------------|
| E | Energy | in-lb |
| W | Weight | lbf |
| M | Mass | W/386.1 |
| V | Velocity | in/s |
| P_d | Driving pressure | lbf/in ² |
| L_H | Head cushion length | in |
| L_C | Cap cushion length | in |
| g | Gravity constant | 386.1 in/sec ² |

Example

TZ cylinder in application 3 and extending:

Using a TZ cylinder with a 4 inch bore and 2.5 inch rod is mounted at a 45° angle from horizontal with rod down. A 3000 lb weight is attached to the rod and system pressure is 1500 psi. The cylinder is moving the weight at 12 in/sec.

Using the calculation for application 3:

$$E = (1/C_{eff}) \{ [0.5 (W/386.1) V^2] - [W L_{hc} \sin(\alpha)] \} \text{ extend}$$

$$E = (1/0.67) \{ [0.5 (3000 / 386.1) * 12^2] + [3000 * 1.378 * \sin(45)] \}$$

$$E = 5,198 \text{ in-lb}$$

Pick the chart (see page 6) for TZ cylinder, rod extending -- third rod. The curve is for the 4 / 2¹/₂ bore/rod model code. Enter the vertical axis at 5,198 in-lb and the horizontal axis at 1500 psi. The point of intersection is below the 4 / 2¹/₂ curve so the cushion is acceptable. The maximum allowable pressure on the cap end is 1901 psi which is greater than the specified system pressure of 1500 psi.

Cushion Data

| Bore Diameter (in.) | Rod Diameter (in.) | Model Code Designation Bore Rod | Max. Cap Pressure (psi) | Effective Cap End Cushion Length (in.) | Effective Rod End Cushion Length (in.) |
|---------------------|--------------------|---------------------------------|-------------------------|--|--|
| 1.5 | 0.625 | CC | 3000 | 1.030 | 0.922 |
| 1.5 | 1.00 | CE | 1797 | 1.030 | 1.181 |
| 2.0 | 1.00 | DE | 2419 | 1.030 | 1.102 |
| 2.0 | 1.375 | DH | 1325 | 1.030 | 1.181 |
| 2.5 | 1.00 | EE | 2568 | 1.030 | 0.834 |
| 2.5 | 1.375 | EH | 2404 | 1.030 | 1.181 |
| 2.5 | 1.75 | EL | 1665 | 1.030 | 1.181 |
| 3.25 | 1.375 | GH | 2685 | 1.187 | 1.186 |
| 3.25 | 1.75 | GL | 2685 | 1.187 | 1.186 |
| 3.25 | 2.00 | GM | 1709 | 1.187 | 1.378 |
| 4.0 | 1.75 | HL | 3000 | 1.260 | 1.299 |
| 4.0 | 2.00 | HM | 2657 | 1.260 | 1.378 |
| 4.0 | 2.50 | HP | 1901 | 1.260 | 1.378 |
| 5.0 | 2.00 | KM | 3000 | 1.181 | 1.575 |
| 5.0 | 2.50 | KP | 2837 | 1.181 | 1.575 |
| 5.0 | 3.00 | KU | 1734 | 1.181 | 1.378 |
| 5.0 | 3.50 | KV | 1734 | 1.181 | 1.378 |
| 6.0 | 2.50 | LP | 3000 | 1.575 | 1.378 |
| 6.0 | 3.00 | LU | 2639 | 1.575 | 1.496 |
| 6.0 | 3.50 | LV | 2639 | 1.575 | 1.496 |
| 6.0 | 4.00 | LW | 2156 | 1.575 | 1.457 |
| 7.0 | 3.00 | MU | 3000 | 1.969 | 1.575 |
| 7.0 | 3.50 | MV | 3000 | 1.969 | 1.575 |
| 7.0 | 4.00 | MW | 2346 | 1.969 | 1.575 |
| 7.0 | 4.50 | MY | 2346 | 1.969 | 1.575 |
| 7.0 | 5.00 | MZ | 1906 | 1.969 | 1.575 |
| 8.0 | 3.50 | NV | 3000 | 2.165 | 1.575 |
| 8.0 | 4.00 | NW | 2934 | 2.165 | 1.575 |
| 8.0 | 4.50 | NY | 2934 | 2.165 | 1.575 |
| 8.0 | 5.00 | NZ | 1969 | 2.165 | 1.575 |
| 8.0 | 5.50 | N1 | 1969 | 2.165 | 1.575 |

Energy Absorbing Potential Charts

**TZ Cap Cushion - Rod Retracting
First Rod**

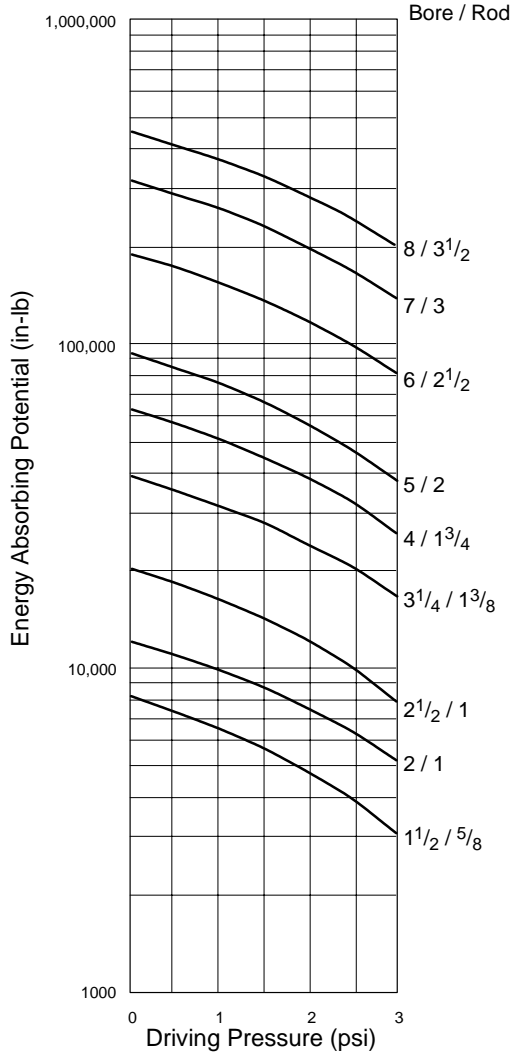

**TZ Rod Cushion - Rod Extending
First Rod**

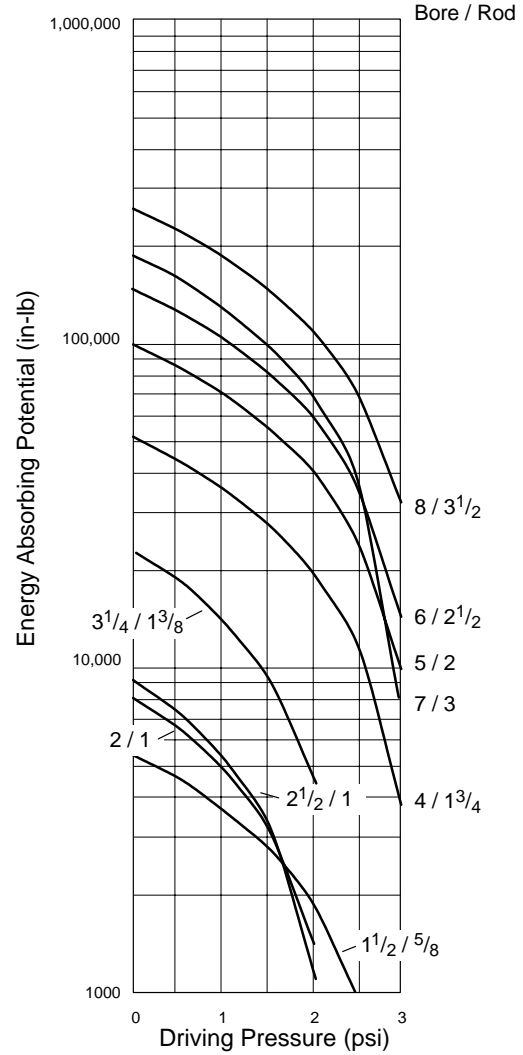

TZ Cap Cushion - Rod Retracting Second Rod

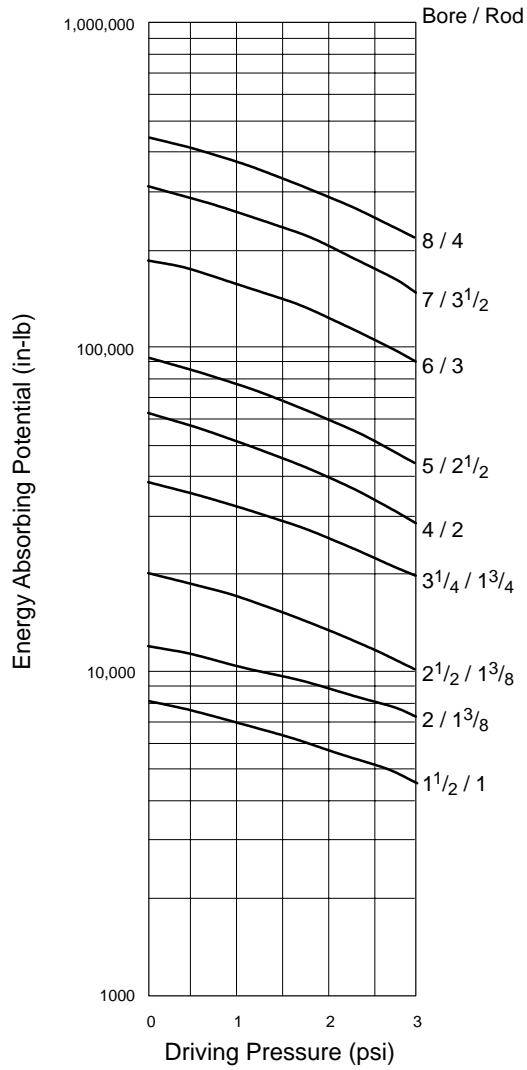

TZ Rod Cushion - Rod Extending Second Rod

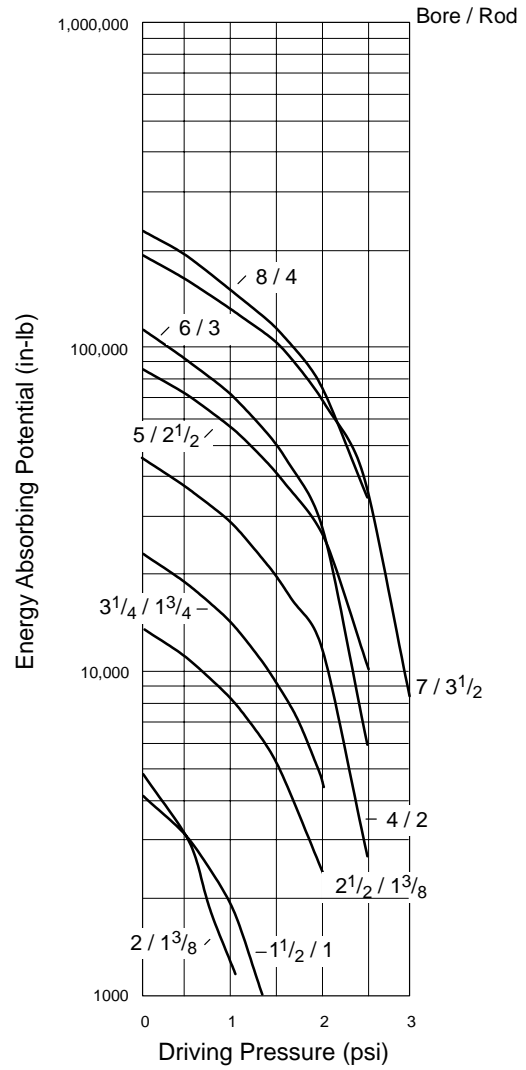

**TZ Cap Cushion - Rod Retracting
Third Rod**

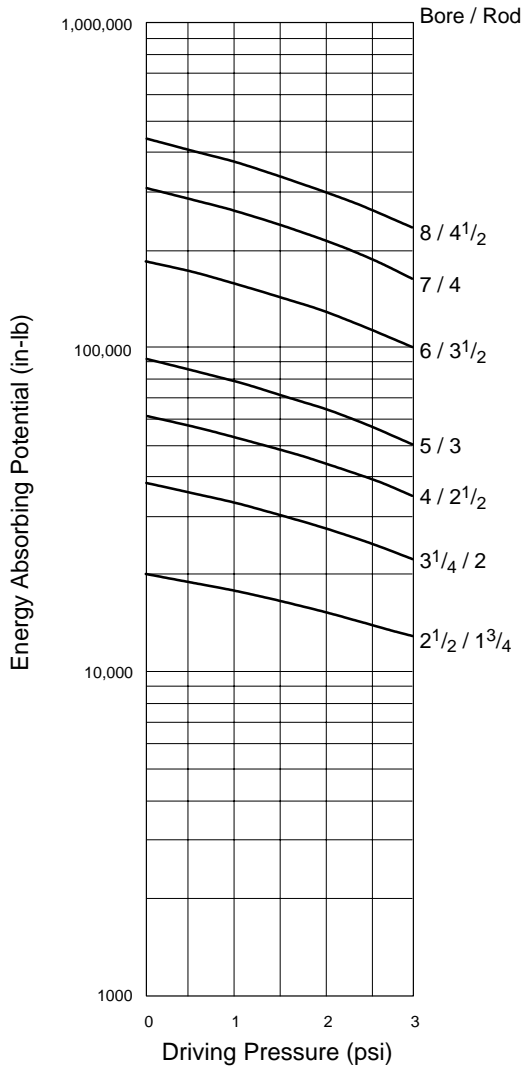

**TZ Rod Cushion - Rod Extending
Third Rod**

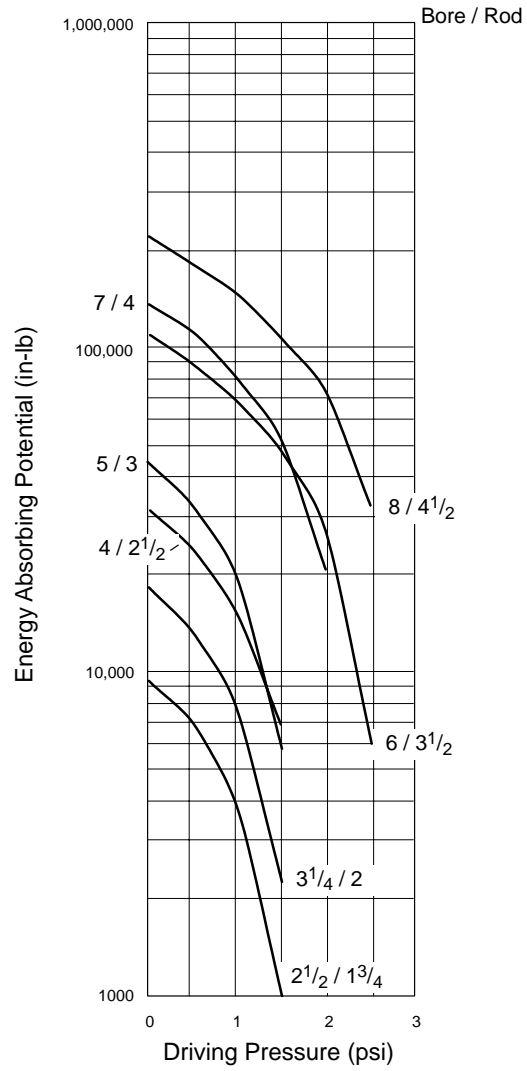

**TZ Cap Cushion - Rod Retracting
Fourth Rod**

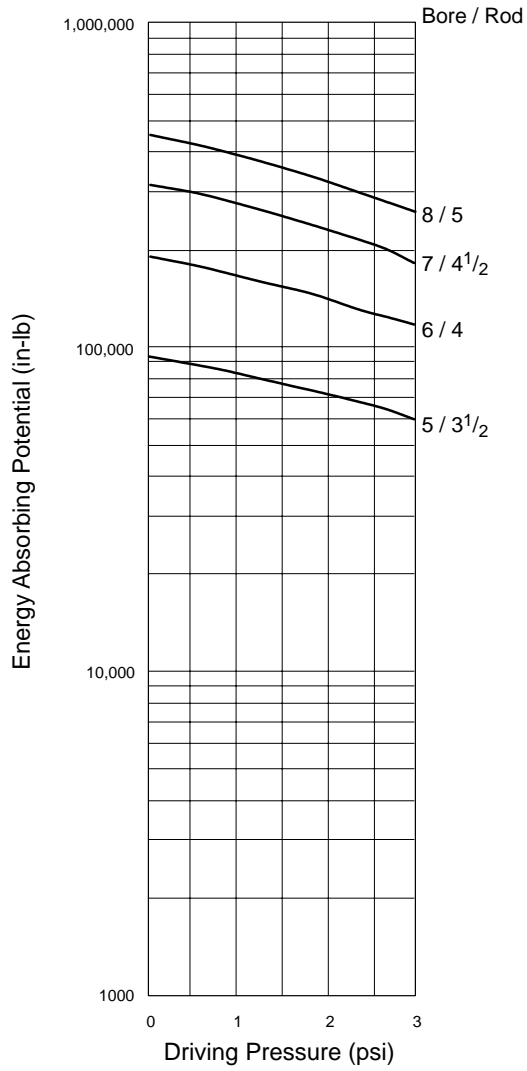

**TZ Rod Cushion - Rod Extending
Fourth Rod**

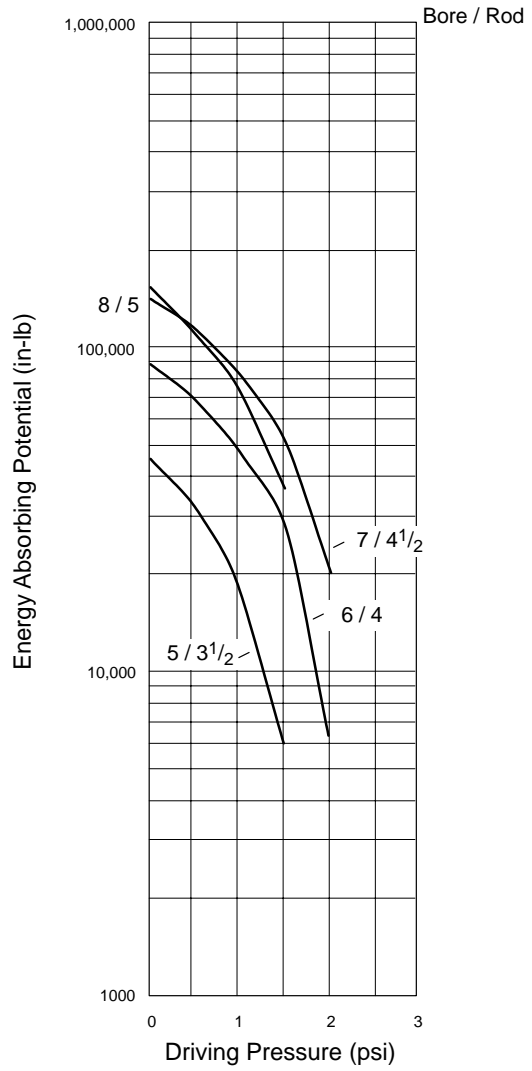

**TZ Cap Cushion - Rod Retracting
Fifth Rod**

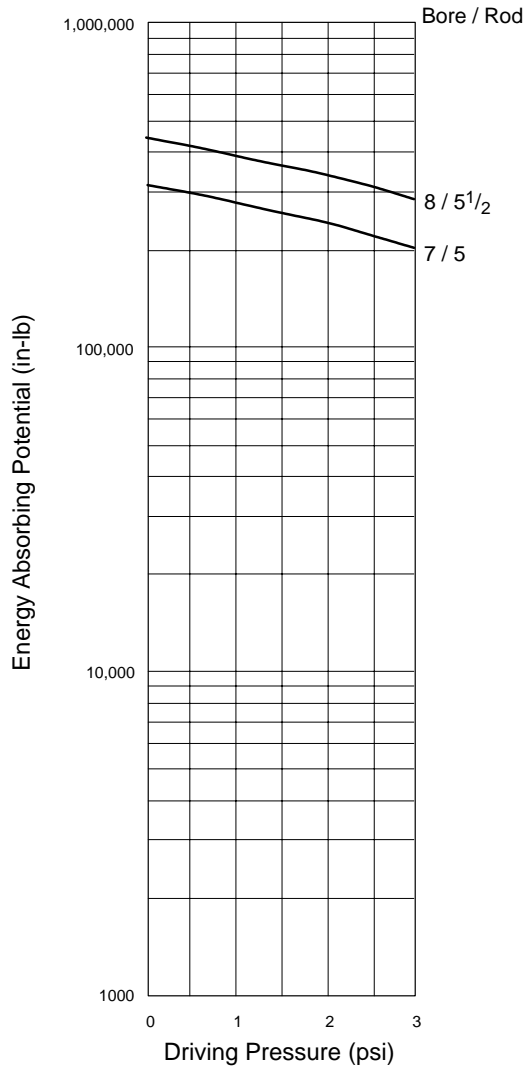

**TZ Rod Cushion - Rod Extending
Fifth Rod**

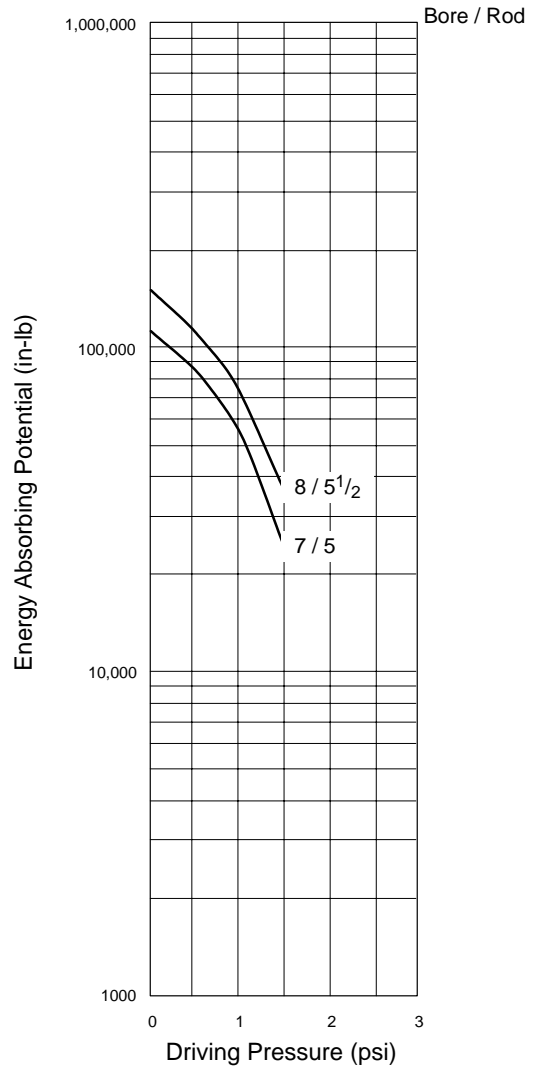

Weights

The following tables list approximate net weights of Series TZ cylinder.

Weights shown are based on cylinders with standard rod diameter and single rod end. All weights are expressed in pounds.

Double rod cylinder weight is equal to 1.15 times the weight listed, plus weight due to stroke.

Approximate Cylinder Weights

| Bore ∅ (in) | TZ01 | TZ02 | | | TZ09 | | | | | TZ16 | TZ21 | Add Per Inch of Stroke | |
|-------------------------------|------|------|------|------|------|------|------|------|------|------|------|------------------------|------------|
| | TZ04 | TZ23 | TZ05 | | TZ14 | | | | | | | Single Rod | Double Rod |
| | TZ19 | TZ24 | TZ07 | TZ08 | TZ15 | TZ10 | TZ12 | TZ13 | TZ17 | TZ22 | | | |
| 1 ¹ / ₂ | 7.8 | 7.7 | 7.7 | 7.9 | 10.6 | 7.6 | 8.2 | 9.1 | 7.7 | 7.5 | .49 | .58 | |
| 2 | 13.0 | 12.4 | 12.7 | 14.2 | 18.0 | 13.2 | 14.0 | 15.7 | 12.7 | 12.0 | .81 | 1.03 | |
| 2 ¹ / ₂ | 19.5 | 16.8 | 17.3 | 20.0 | 22.9 | 17.6 | 19.1 | 21.1 | 17.0 | 16.4 | 1.06 | 1.28 | |
| 3 ¹ / ₄ | 34.0 | 32.2 | 33.0 | 37.0 | 46.0 | 34.0 | 36.7 | 40.4 | 33.0 | 31.5 | 1.76 | 2.18 | |
| 4 | 48.8 | 43.3 | 45.0 | 49.3 | 58.7 | 50.2 | 50.4 | 55.0 | 44.0 | 42.5 | 2.23 | 2.91 | |
| 5 | 84.0 | 81.3 | 84.3 | 91.0 | 101 | 92.4 | 81.0 | 98.4 | 79.3 | 80.0 | 3.90 | 4.79 | |
| 6 | 136 | 128 | 131 | 143 | 155 | 141 | 144 | 154 | 125 | 125 | 5.17 | 6.56 | |
| 7 | 204 | 190 | 194 | 210 | 235 | 215 | 209 | 223 | 191 | 186 | 6.47 | 8.47 | |
| 8 | 273 | 263 | 264 | 285 | 323 | 293 | 284 | 302 | 260 | 256 | 8.91 | 11.63 | |

Additional locations:

Vickers, Incorporated
7638 Pacific Avenue
White City, Oregon 97503-1091
U.S.A.
Phone: 503-826-2131
Fax: 503-826-3344

Vickers, Incorporated
Route1, Box 17
250 Courtland Road
Decatur, Alabama 35603
U.S.A.
Phone: 205-353-2001
Fax: 205-351-9224

VICKERS

Vickers, Incorporated
2425 W. Michigan Avenue
Jackson, Michigan 49202-3984
U.S.A.
Phone: 517-787-7220
Fax: 517-787-3450