

WLS28 Work Light Strip

General-purpose LED work lighting for IP50 and IP67/IP69K environments



For the latest technical information about this product, including specifications, dimensions, and wiring, see www.BannerEngineering.com

Features



- High power solid state LED array
- Designed for enclosure or area lighting
- Rugged aluminum housing
- Narrow 28 mm total width
- Lighted lengths available from 145 mm to 1130 mm
- Low-profile design with included swivel mounting brackets
- Illuminates a large area with an even pattern of light and no shadows
- 12 to 30V dc operation
- Cabled and Quick Disconnect models available
- Stand-alone and cascadable models available
- IP50 and IP67/IP69K models available
- IP50 models available with or without ON/OFF switch
- Low power consumption; less than 9 watts per foot



NOTE: When cascading lights, a model with an ON/OFF switch can be used to control the lights cascaded off of the switched model.

Work Light Strip Models

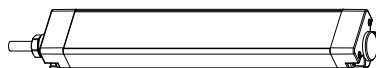

Stand-Alone Light—cable

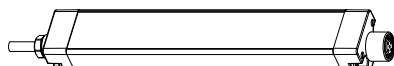

First Light in a Cascade—cable

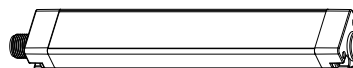

Stand-Alone Light or End Light in a Cascade—QD

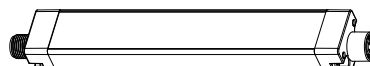

First or Middle of a Cascade—QD

WLS28 Work Light Strips are available as either stand-alone models, or as cascade models that can be "daisy-chained" together for a continuous length of lighting, with a minimum of wiring.

Stand-alone models have cable or male QD fitting at one end for power connection, no connections at opposite end. A stand-alone model may be used as the last in the cascade series.

Cascade models have cable or male QD fitting at one end for power connection, female QD fitting at opposite end for connection to other lights in the cascade. Cascade models with cable end can only be used as the first light in the cascade series. A double-ended accessory cordset (see [Cordsets](#) on page 6) must be used between each pair of lights in a cascade.



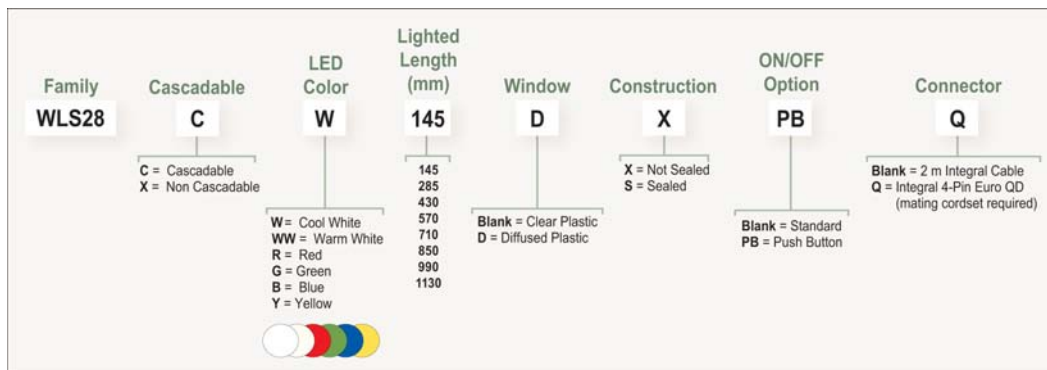

Table 1: IP50 Models

Non-Switch Models		ON/OFF Switch Models		Lighted Length	Power Connector*
Stand-Alone	Cascade	Stand-Alone	Cascade		
WLS28XW145X	WLS28CW145X	WLS28XW145XPB	WLS28CW145XPB	145 mm	2 m cable
WLS28XW285X	WLS28CW285X	WLS28XW285XPB	WLS28CW285XPB	285 mm	
WLS28XW430X	WLS28CW430X	WLS28XW430XPB	WLS28CW430XPB	430 mm	
WLS28XW570X	WLS28CW570X	WLS28XW570XPB	WLS28CW570XPB	570 mm	
WLS28XW710X	WLS28CW710X	WLS28XW710XPB	WLS28CW710XPB	710 mm	
WLS28XW850X	WLS28CW850X	WLS28XW850XPB	WLS28CW850XPB	850 mm	
WLS28XW990X	WLS28CW990X	WLS28XW990XPB	WLS28CW990XPB	990 mm	
WLS28XW1130X	WLS28CW1130X	WLS28XW1130XPB	WLS28CW1130XPB	1130 mm	

*Only cabled power connector models are listed. For 4-pin M12/Euro-style integral power connector, add suffix **Q** to the model number (for example, **WLS28XW285XQ**).

Table 2: IP67/IP69K Models

Models		Lighted Length	Power Connector*
Stand-Alone	Cascade		
WLS28XW145S	WLS28CW145S	145 mm	2 m cable
WLS28XW285S	WLS28CW285S	285 mm	
WLS28XW430S	WLS28CW430S	430 mm	
WLS28XW570S	WLS28CW570S	570 mm	
WLS28XW710S	WLS28CW710S	710 mm	
WLS28XW850S	WLS28CW850S	850 mm	
WLS28XW990S	WLS28CW990S	990 mm	
WLS28XW1130S	WLS28CW1130S	1130 mm	

*Only cabled power connector models are listed. For 4-pin M12/Euro-style integral power connector, add suffix **Q** to the model number (for example, **WLS28XW285SQ**).

Specifications

Supply Voltage and Current

12 to 30V dc (10% max. ripple)

Use only with suitable Class 2 power supply.

Max current and power per length:

Light Length	12V dc	24V dc	30V dc	Watts	Lumens* (Typical @ 25° C)					
					Cool Wht	Wrm Wht	Grn	Red	Yel	Blu
145 mm	0.5A	0.25A	0.2A	6	225	180	126	60	114	36
285 mm	0.75A	0.375A	0.3A	9	450	360	252	120	228	72
430 mm	1.25A	0.625A	0.5A	15	675	540	378	180	342	108
570 mm	1.5A	0.75A	0.6A	18	900	720	504	240	456	144
710 mm	2.0A	1.0A	0.8A	24	1125	900	630	300	570	180
850 mm	2.25A	1.125A	0.9A	27	1350	1080	756	360	684	216
990 mm	2.75A	1.375A	1.1A	33	1575	1260	882	420	798	252
1130 mm	3.0A	1.5A	1.2A	36	1800	1440	1008	480	912	288

* Lumen values lowered by 35% on diffused window models

Light Characteristics

Color Temperature and Wavelengths

Cool White: 5000 - 8300K

Warm White: 2600 - 4300K

Green: 520 - 535nm

Red: 620 - 630nm

Yellow: 585 - 595nm

Blue: 460 - 475nm

Useful Life

When operating within specifications, output will decrease less than 30% after 50,000 hours.

Construction

Clear anodized aluminum housing; painted zinc end caps; acrylic window; zinc plated steel brackets

Mounting

(2) swivel brackets SMBWLS28RA included and (4) screws

Environmental Rating

IEC IP50 (non-sealed models) or IEC IP67/IP69K per DIN 40050 (sealed models)



NOTE: Do not spray cable with high-pressure sprayer, or cable damage will result.

Connections

Integral 4-pin Euro style QD, or 2 m (6.5') integral cable

Operating Temperature

-20° to +50° C (-4° to +122° F)

Storage Temperature

-40° to +70° C (-40° to +158° F)

Certifications

IP50 models:



IP67/IP69K models: ; UL Pending

Application Notes

When connecting cascable lights in series it is important not to exceed maximum current limitations:

Maximum length of light at 12V dc: 1.5 m

Maximum length of light at 24V dc: 3.0 m

Maximum length of light at 30V dc: 3.1 m

Dimensions

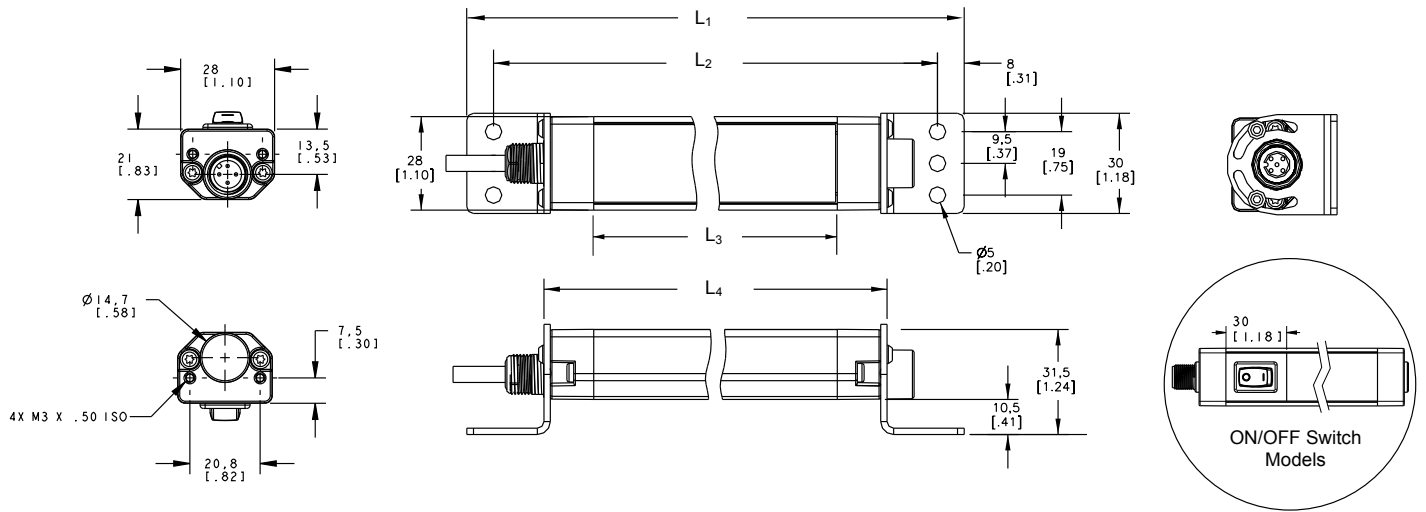

Dimensions are shown with included SMBWLS28RA bracket

Non-Switch Models					
IP50 Models	IP67/IP69K Models	L ₁	L ₂	L ₃	L ₄
WLS28..145X	WLS28..145S	221 mm (8.7")	205 mm (8.1")	145 mm (5.71")	175 mm (6.9")
WLS28..285X	WLS28..285S	362 mm (14.3")	346 mm (13.6")	286 mm (11.26")	316 mm (12.4")
WLS28..430X	WLS28..430S	503 mm (19.8")	487 mm (19.2")	427 mm (16.81")	457 mm (18.0")
WLS28..570X	WLS28..570S	644 mm (25.4")	628 mm (24.7")	568 mm (22.36")	598 mm (23.5")
WLS28..710X	WLS28..710S	785 mm (30.9")	769 mm (30.3")	709 mm (27.91")	739 mm (29.1")
WLS28..850X	WLS28..850S	926 mm (36.5")	910 mm (35.8")	850 mm (33.46")	880 mm (34.6")
WLS28..990X	WLS28..990S	1067 mm (42")	1051 mm (41.4")	991 mm (39.02")	1021 mm (40.2")
WLS28..1130X	WLS28..1130S	1208 mm (47.6")	1192 mm (46.9")	1132 mm (44.57")	1162 mm (45.7")

ON/OFF Switch Models				
Model	L ₁	L ₂	L ₃	L ₄
WLS28..145XPB	251 mm (9.9")	235 mm (9.3")	145 mm (5.71")	205 mm (8.1")
WLS28..285XPB	392 mm (15.4")	376 mm (14.8")	286 mm (11.26")	346 mm (13.6")
WLS28..430XPB	533 mm (21.0")	517 mm (20.4")	427 mm (16.81")	487 mm (19.2")
WLS28..570XPB	674 mm (26.5")	658 mm (25.9")	568 mm (22.36")	628 mm (24.7")
WLS28..710XPB	815 mm (32.1")	799 mm (31.5")	709 mm (27.91")	769 mm (30.3")
WLS28..850XPB	956 mm (37.6")	940 mm (37")	850 mm (33.46")	910 mm (35.8")
WLS28..990XPB	1097 mm (43.2")	1081 mm (42.6")	991 mm (39.02")	1051 mm (41.4")
WLS28..1130XPB	1238 mm (48.7")	1222 mm (48.1")	1132 mm (44.57")	1192 mm (46.9")

Wiring

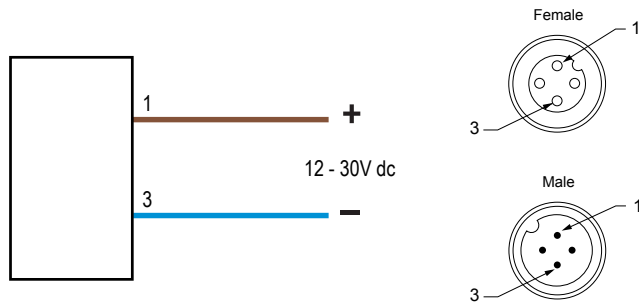

Wiring Key:

- 1 = Brown
- 3 = Blue

Accessories

Replacement Bracket and Unistrut Mounting Hardware

SMBWLS28RA

The bracket kit is available as a replacement for the one that comes with the Work Light Strip. The kit contains 2 end brackets, 4 screws.



SMBWLS28SM

This kit allows the light to be mounted at a right angle to the mounting surface. The kit contains 2 end brackets, 4 screws.



SMH1316

This kit allows the light to be mounted to a 13/16" Unistrut channel. The kit includes:

- 2 X 10-32 spring nuts
- 2 X 10-32 socket head cap screws
- 2 X #10 lock washers

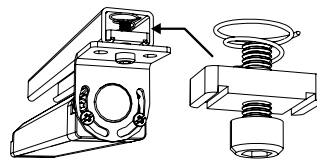

Cordsets

Single-ended cordsets are for use between power source and QD connection of stand-alone light or first light in a cascade.

Double-ended cordsets are for use between lights in a cascade.

Single-Ended Cordsets

4-Pin M12/Euro-Style Cordsets (straight connector)

MQDC-406, 2 m (6.5')

MQDC-415, 5 m (15')

MQDC-430, 9 m (30')

4-Pin M12/Euro-Style Cordsets (right-angle connector)

MQDC-406RA, 2 m (6.5')

MQDC-415RA, 5 m (15')

MQDC-430RA, 9 m (30')

Double-Ended Cordsets

4-Pin M12/Euro-Style Cordsets — Double-Ended (straight male/straight female connectors)

MQDEC-401SS, 0.3 m (1')

MQDEC-403SS, 1 m (3')

MQDEC-406SS, 2 m (6.5')

MQDEC-412SS, 4 m (12')

MQDEC-420SS, 7 m (23')

MQDEC-430SS, 10 m (33')

MQDEC-450SS, 15 m (50')

Splitter Cordsets

4-Pin M12/Euro-Style Cordsets — Splitter

CSB-M1240M1240, 10 mm (0.4") male trunk; 2 x 10 mm (0.4") female branches

CSB-M1241M1241, 0.3 m (1') male trunk; 2 x 0.3 m (1') female branches

CSB-M1248M1241, 2.5 m (8') male trunk; 2 x 0.3 m (1') female branches

CSB-M12415M1241, 5 m (15') male trunk; 2 x 0.3 m (1') female branches

CSB-M12425M1241, 8 m (26') male trunk; 2 x 0.3 m (1') female branches

CSB-UNT425M1241, 8 m (26') unterminated trunk; 2 x 0.3 m (1') female branches

